

ACCUTRON®

Service Manual

Series 214

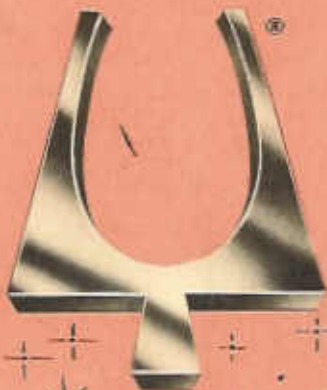

979



by **BULOVA®**

TABLE OF CONTENTS

	<i>page</i>
Foreword	1
Special Tools and Equipment	2
Microscope	2
ACCUTRON Service Kit	2
Cleaning Equipment	5
Rate Recorder	5
Diagnosis	6
Special Points	8
Procedures for Testing	9
How to Check Power Cell	9
How to Open Case and Remove Movement	10
Regulation	11
Checking Electronic Circuit	13
How to Expose Indexing Mechanism	13
Indexing Mechanism—Inspection and Adjustment	14
Checking the Train for Freedom	17
Procedures for Disassembly	18
How to Remove Hands, Dial and Dial Train	18
How to Remove Coil and Fork Assembly	19
Cleaning	21
Oiling	22
Procedures for Reassembly	24
Replacement of Coil and Fork Assembly	24
Replacement of Dial Train, Dial and Hands	26
Casing the Movement	27
Regulation Following Repair	28
Information and Hints for the ACCUTRON Repairman	30
Parts List	34
Index	36

"BULOVA," "ACCUTRON," "WATCHMASTER" and " are registered trademarks of BULOVA WATCH COMPANY, INC.

All information contained in this booklet is based on the latest product information available at the time of printing. The right is reserved to make changes at any time without notice.

FOREWORD

It takes years to train a watchmaker to repair an ordinary watch. But any watchmaker should be able to learn to service the ACCUTRON movement in a matter of hours with the aid of this manual. All the information a watchmaker needs to perform the diagnostic and service operations on ACCUTRON is contained in this manual; study it thoroughly.

There are certain ways in which the servicing of ACCUTRON differs from familiar watchmaking practices. In the first place, there is no necessity for preventive maintenance. Secondly, an extremely precise method of diagnosis and testing has been devised, and should be followed in determining the cause of the malfunction.

There are two general areas of operation in the ACCUTRON movement: the Mechanical components, consisting of the indexing mechanism and the gear train; and the Electronic and Electromagnetic components, consisting of the Power Cell, electronic circuit and tuning fork. The purpose of the method of diagnosis as described in this manual is to localize the source of trouble.

The indexing mechanism, which transmits the motion of the tuning fork to the gear train, and forms a most important part of the Mechanical area of the ACCUTRON movement, contains parts so small that their functioning cannot be checked with a loupe. Consequently, a microscope *must* be used for this purpose. If the microscopic examination discloses need for adjustment, it can usually be accomplished with the lower magnification of a loupe.

With the exception of the above, the servicing of ACCUTRON generally utilizes skills and operations which are familiar to the watchmaker. This manual has been written to give you all the information needed to service the basic ACCUTRON movement (Model 214). It has been arranged in a way which will be of maximum value to you. Additional information or assistance on specific problems is available from Technical Sales & Services Division of the Bulova Watch Company.

SPECIAL TOOLS AND EQUIPMENT

microscope

The examination of the operation of the indexing mechanism is the most critical check in diagnosing trouble in the ACCUTRON timepiece. The index wheel is extremely small (2.40 mm in diameter) and contains 300 teeth which are .02 mm apart. The jewels which engage with this wheel are .18 mm square by .06 mm thick. These dimensions are so small that a microscope is necessary to obtain the level of magnification required to check the functioning of the indexing mechanism.

Any microscope of reasonable quality is satisfactory, provided that it meets the following specifications: 20-30 diameters magnification; fairly wide field; upright image; at least 2 inches working distance. Your authorized Bulova Watch Material Distributor stocks a relatively low-priced Bulova "Microloupe" which is adequate for this purpose.

Note: The typical biological or metallurgical microscopes are not suitable for this use because they have small fields, short working distances and give inverted images.

ACCUTRON *service kit*

Four special tools have been designed by the engineering staff of the Bulova Watch Company, Inc. to perform diagnosis and to service the 214 ACCUTRON timepiece. These tools are included in the new Authorized ACCUTRON Service Kit.

1. A special triple-purpose electric Test Set
2. A molded plastic Movement Holder
3. A special Locking-ring Wrench
4. An Index Finger Post Wrench

Each item will be described (pages 3-5) and its use fully explained and illustrated in the sections of this manual covering diagnosis and servicing, disassembly and reassembly.

test set

The Test Set, illustrated in Fig. 1, is an essential unit in servicing the ACCUTRON movement. The Test Set is required to perform three very important functions:

1. It is used as a voltmeter to check the ACCUTRON Power Cells.
2. It is designed to check the current in the electronic circuit, to indicate its operating condition. (Conventional high-resistance microammeters are not suitable for this purpose.)
3. It provides an accurate source of the reduced voltage required for the adjustment of the indexing mechanism.

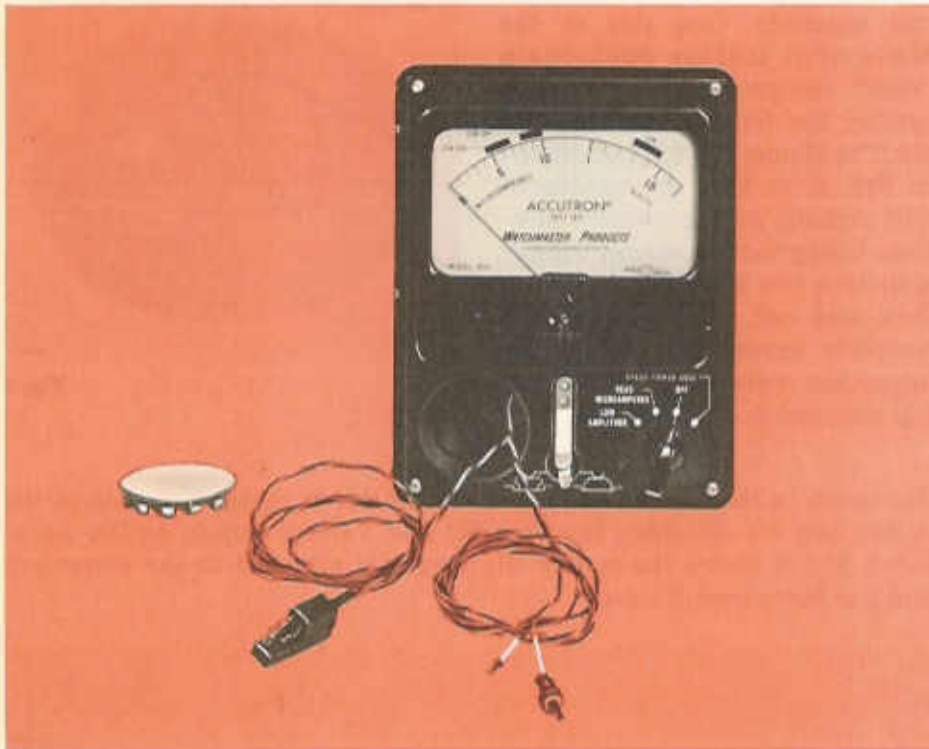

Fig. 1

The Test Set provides:

1. A "nest" to hold a Power Cell during testing. The nest is clearly marked for proper insertion of the 214 Power Cell.
2. A meter, reading either volts or microamperes, indicating the correct values by areas marked "OK."
3. A 4-position Rotary Switch for the selection of the various test conditions:
 - Position 1 — "CHECK POWER CELL"
 - Position 2 — "OFF"
 - Position 3 — "READ MICROAMPERES"
 - Position 4 — "LOW AMPLITUDE". In this position the Test Set provides an accurate source for the reduced voltages required for the indexing mechanism adjustment, in both the 214 and 218 ACCUTRON movements (the two voltages are not the same).
4. A 2-wire lead, with a tab end and a plug end for attachment to the 218 ACCUTRON movement and movement holder.
5. A 2-wire lead, with a spring clip for attachment to the 214 ACCUTRON movement.
6. A black screw, directly below the center of the movement dial, for zeroing the meter hand.

movement holder

Because of the unique construction of the ACCUTRON timepiece it is essential that a special Movement Holder be used. A specially designed holder has been developed to fit the ACCUTRON movement and to protect the tuning fork and coil assembly during servicing procedure. A CLAMP-TYPE MOVEMENT HOLDER SHOULD NOT BE USED WHEN ADJUSTING THE 214 INDEXING MECHANISM.

The Movement Holder (Fig. 2) is used when removing the fork and coil assembly. One side of the Movement Holder contains a "nest" designed to receive and protect the fork and coil assembly. The Holder is keyed, as shown in Fig. 2, so that the movement will remain in the correct position. Using the Movement Holder simplifies the handling of tuning fork and coil modules, and the complete movement, during the important adjustment and testing outlined in this manual.



Fig. 2

The notch in the side of the Movement Holder is designed to accept the spring clip for attaching the Test Set and Voltage Supply to the movement. Fig. 3 shows the spring clip correctly attached to the movement and the Movement Holder.

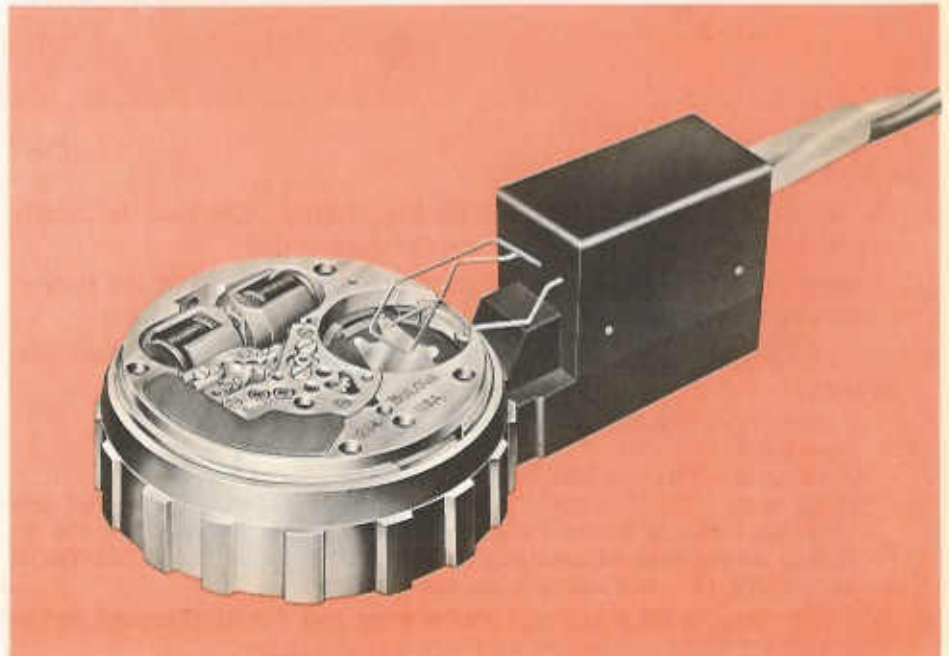

Fig. 3

locking-ring wrench

Because of the convexity of the back of the ACCUTRON timepiece, a conventional locking-ring wrench may not be suitable for opening the case of water-resistant models. A special wrench, designed for this purpose, is illustrated in Fig. 4.

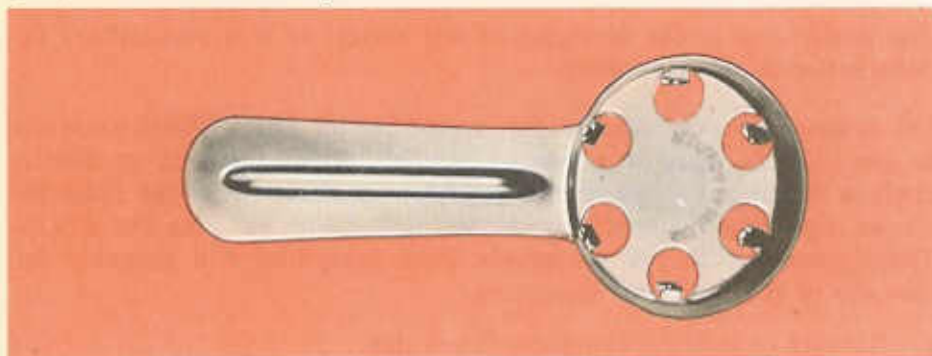

Fig. 4

index finger post wrench

This special wrench, illustrated in Fig. 5, is used in the alignment of the index fingers. It is placed over the end of the index finger post on the tuning fork tine, and gently stressed to center the index jewel on the index wheel by slightly bending the index finger post.



Fig. 5

cleaning equipment

Ultrasonic cleaning of the mechanical section of the ACCUTRON movement is strongly recommended. The infinitesimal size of the 300 teeth on the beryllium-copper index wheel requires the maximum penetration power available in ultrasonic cavitation generated by nickel transducers. The WATCHMASTER Ultrasonic Watch Cleaner is recommended. It was used exclusively during the development of the ACCUTRON timepiece.

rate recorder

The true rate of the ACCUTRON tuning fork can be recorded only on equipment specifically designed for that purpose. A special transistorized amplifier, with suitable frequency dividers, has been developed by Bulova engineers to show this true rate. This ACCUTRON Rate Recorder will also record popular odd beat, spring driven and electric watches. By printing comparative graphs it will greatly assist in the sales effort of fine timepieces.

NOTE: For further information on the ACCUTRON Service Kit, the ACCUTRON Power Cell Tester*, the WATCHMASTER Ultrasonic Cleaner or the Special ACCUTRON Rate Recorder, write to: Technical Sales & Services Division
Bulova Watch Company, Inc.
Bulova Park
Flushing, N. Y. 11370

* Not shown in this publication

DIAGNOSIS

The initial step in the servicing of any timepiece is a preliminary determination of the symptoms.

Let us assume that a customer has brought in an ACCUTRON timepiece to you. Unless there is a broken crystal, catching hands or similar obvious defects, it is important to obtain a *clear statement* from the owner regarding the symptoms which caused him to bring the ACCUTRON timepiece to you for repair. Such symptoms will probably fall into one of the following categories:

1. Gaining or losing a few seconds per day.
2. Gaining or losing an excessive amount (one or more minutes per week).
3. Stopped.

We differentiate between Nos. 1 and 2 because, unlike ordinary watches where gains or losses of large amounts can be corrected by regulation, ACCUTRON is so designed that the usual wearing conditions or environmental effects will rarely affect timing more than a few seconds per day. An ACCUTRON timepiece which gains or loses more than a minute a week probably requires servicing, not regulation.

There is one symptom that you should look for in your preliminary examination: if the timepiece is stopped, be sure to listen carefully to determine whether or not the characteristic hum is audible.

The method of diagnosis consists of procedures whereby you progressively narrow down the areas of possible malfunction. Having determined from your own examination or the customer's description whether: (a) the timepiece is running, (b) how much it is gaining or losing, and, (c) whether the hum is audible, you are already on your way toward localizing the source of the trouble. For example, if an ACCUTRON timepiece is brought in to you, and upon examination, you see it is not running but the characteristic hum is audible, you can conclude that the electronic circuit is operating, and the fork is vibrating. Under these conditions, if the Power Cell voltage is proper, this means that the source of trouble is probably somewhere beyond the fork; perhaps in the indexing linkage, or in the gear train which connects the indexing mechanism with the hands. On the other hand, if the hum is not heard, this is an indication that there is probably some malfunction in the Power Cell, in the electronic circuit, or that the fork is mechanically blocked. The procedures shown in the Servicing Table on the next page further narrow down the possible choices until the correct source of the trouble is found.

This table, which is self-explanatory, covers most of the servicing situations that will normally arise. The first column lists the symptoms; the second column, the possible sources of trouble which could cause this particular symptom; the third column details the procedure that you should follow in determining which of the possible causes is the correct one; and the fourth column lists the corrective steps to be taken when the malfunction is isolated.

PROBLEM	POSSIBLE CAUSES (In order of probability)	DIAGNOSIS PROCEDURE	REMEDIAL ACTION
GAINING OR LOSING A FEW SECONDS PER DAY	Abnormal wearing habits or Improper regulation	(See "irregular timekeeping" page 30.)	Regulate (page 11)
STOPPED (No hum)	<ol style="list-style-type: none"> 1. Exhausted Power Cell 2. Faulty electronic circuit 3. Mechanical blockage of tuning fork 4. Faulty electronic circuit 	<p>Check Power Cell voltage (page 9). If low or no voltage, Power Cell is exhausted.</p> <p>If voltage is normal, check current (page 13). If no current, electronic circuit is faulty</p> <p>If current is high, check if tuning fork is blocked</p> <p>If no blockage of tuning fork, electronic circuit is faulty</p>	<p>Replace Power Cell</p> <p>Replace complete coil assembly (Part No. 711)</p> <p>Find blockage and remove it</p> <p>Replace complete coil assembly (Part No. 711)</p>
STOPPED (Sweep second hand does not turn but fork hums)	<ol style="list-style-type: none"> 1. Exhausted Power Cell 2. Indexing mechanism maladjustment 3. Mechanical blockage of train 4. Dirt on index wheel 5. Damaged teeth on index wheel 	<p>Check Power Cell voltage (page 9). If voltage is low, Power Cell is exhausted</p> <p>If voltage normal, open case, remove movement (page 10), expose indexing mechanism (page 13), and examine under microscope. Check index jewel engagement (pages 14 and 15, steps 2 and 4)</p> <p>If jewels appear normal, check train freedom (page 17). Train may be blocked</p> <p>If train is free, and index jewel engagement is correct, tap movement lightly with pencil to increase fork amplitude, while observing closely with loupe. If index wheel rotates once and then stops again, this is evidence of dirt on index wheel tooth</p> <p>If symptoms persist after cleaning, index wheel has been damaged</p>	<p>Replace Power Cell</p> <p>Readjust indexing mechanism if necessary (pages 14 thru 17)</p> <p>Find mechanical blockage and remove it</p> <p>Clean entire movement as described on page 21 in ultrasonic cleaner</p> <p>Change index wheel</p>
GAINING OR LOSING EXCESSIVELY	<ol style="list-style-type: none"> 1. Tuning fork not free 2. Defective coil 3. Mechanical interference in train 4. Foreign material clinging to magnetic elements 5. Indexing mechanism maladjustment 6. Dirt in index wheel teeth 	<p>Open case, remove movement (page 10) and check current (page 12). If current too high, examine for obvious foreign material interfering with free vibrations of tuning fork</p> <p>If current too high and no evidence tuning fork is not free, expose indexing mechanism (page 13), disengage pawl jewel (item 6 page 16) and check current again. If current remains high, coil assembly is defective</p> <p>If current drops within "OK" range or below in 2, above, cause is excessive train friction.</p> <p>If current is "OK" in 1, above, and rate is many seconds per day slow, check for loose screw or other matter clinging to a tuning fork magnet</p> <p>If current is "OK" in 1, above, indexing mechanism may be out of adjustment</p> <p>If current and indexing mechanism adjustment have been found correct, there may be dirt in index wheel teeth</p>	<p>If foreign matter is observed, remove same and recheck to see that current is normal</p> <p>Replace complete coil assembly (Part No. 711)</p> <p>Find interference and remove it</p> <p>Find foreign matter and remove same</p> <p>Check and readjust indexing mechanism as necessary (pages 14 thru 17)</p> <p>Clean entire movement (page 21)</p>

SPECIAL POINTS:

Because of the unusual and somewhat unfamiliar nature of the ACCUTRON mechanism, there are certain areas in which extreme care should be exercised. Attention is called to these precautions in the various applicable sections of this manual, but in order to emphasize their importance they are listed again below:

1. In removing the hands, care must be taken not to turn the center second pinion forward, or force it backward, since this will damage the indexing mechanism.
2. The post, finger, and jewel assemblies on the tuning fork (the index finger), and on the pawl adjusting bridge (the pawl finger) are very delicate. Handling of these assemblies should be kept to a minimum, and should be done, when necessary, with great care. If either finger is damaged, or if either jewel is separated from its finger, the entire assembly must be replaced. The jewels cannot be re-cemented or the fingers replaced, except in the factory.
3. The teeth on the index wheel do not wear away unless the train has been blocked in some manner for an extended period. In this case, a tooth can be worn off by the constant rubbing of the index jewel at one spot on the wheel. Other than this, the index wheel can only be damaged by improper handling of the movement when it is not protected by the timepiece case. Unfortunately, if an index wheel has been damaged during servicing (or by a stalled train) this cannot be confirmed by visual observation with the recommended microscope. Furthermore, the purchase of a high power microscope, with suitable fixturing and illumination for examining the teeth on the index wheel, is rarely warranted because of the cost factor. If it is suspected that the teeth on the index wheel have been damaged the most practical solution is to replace the wheel and pinion assembly, Part No. 112. In this case, to avoid damaging the teeth, always handle the assembly by the pinion, and in no case grasp the edge of the wheel with tweezers.
4. In removing the complete coil assembly care should be taken to avoid damaging the insulation on the connecting wires, or piercing the insulation on the coils.
5. Do not demagnetize an ACCUTRON movement, or expose it to any high-strength magnetic field. Anything which will affect the permanent magnets on the tuning fork will seriously affect the operation of the timepiece. (See page 32.)
6. If necessary to remove the tuning fork from the ACCUTRON movement, as in cleaning, keep the fork away from anything made of steel: tools, containers, watch parts, etc. The magnets on the tuning fork are extremely powerful, and will have a tendency to attract small articles, and be attracted to large articles, either of which may damage the fork.
7. Never oil the teeth of the index wheel, or the index or pawl jewels.
8. Never bend the tines of the tuning fork. Bending this part will seriously affect its timekeeping ability. If the tines become misaligned, or the fork is damaged in any way, it must be replaced.

PROCEDURES FOR TESTING

how to check 214 power cell



Before any other work is done, check the Power Cell to make sure that it is functioning properly.

1. Wipe the back of the case to remove any loose material near the Cell cover (to prevent the entrance of dirt when the cover is removed).
2. Unscrew the Cell compartment cover using a U.S. dime.
3. Turn the timepiece over and the Cell will fall out.
4. Place the Power Cell in the nest of the Test Set with the smaller diameter *down*.
5. Turn the rotary switch to "CHECK POWER CELL" position.
6. Read the Power Cell Voltage on the right-hand scale. The voltage reading should be in the "OK" area of the scale (1.25 to 1.45 volts). If it is, the Power Cell is in satisfactory operating condition.

Note: Poor electrical contact between Power Cell and Test Set will cause either a low reading or a wavering indication of cell voltage. It can be readily avoided by making certain that Cell surfaces and contacting points of the Test Set nest and clip are clean. Rubbing or twisting a suspected cell between the contacts while checking voltage is good practice. A wavering reading of voltage is *always* an indication of poor contact, *not* an indication of a bad cell. Testing should always be done with the authorized ACCUTRON Test Set or with a high-resistance voltmeter (having not less than 10,000 ohms per volt sensitivity), such as the ACCUTRON Power Cell Tester*.

CAUTION: Use only cells imprinted "ACCUTRON 214" (see picture above) in this model timepiece. Cells marked "ACCUTRON 218" will not operate the Series 214 movement. Substitutes, such as type 400 hearing-aid cells, should *never* be used since they may leak and seriously damage the movement. Their internal construction and electrolyte differ from that in the genuine 214 cell.

* Not shown in this publication

*how to open case
and remove movement*

1. Using special Locking-ring Wrench, loosen locking ring.
2. Remove locking ring.
3. Lift setting handle to aid in removing back.
4. Lift off back, being careful to lift straight up.
5. If gasket is pulled up in lifting back, remove it. (If gasket remains in case, it is not necessary to remove it for the regulation procedure.)
6. The movement can now be removed from the case. (Regulation can be accomplished without taking the movement out of the case, or removing the Power Cell.)



regulation

THE BASIC ACCURACY OF ACCUTRON IS SO GREAT THAT REGULATION FOR MORE THAN A FEW SECONDS PER DAY IS NOT REQUIRED. GAINS OR LOSSES OF AS MUCH AS A MINUTE A WEEK INDICATE THE NEED FOR SERVICING, NOT REGULATION.

ACCUTRON regulators

The ACCUTRON regulators (see Fig. 7, page 12) are serrated to make them easier to rotate and to serve as a calibration.

The serrations of each regulator form 7 divisions (4 projections and 3 indentations). Each of these divisions is equal to 2 seconds per day of correction; in other words, rotating one of the regulators a distance equal to one division, changes the rate of the ACCUTRON timepiece by 2 seconds per day. Regulation for as little as $\frac{1}{2}$ second per day can be made by rotating one of the regulators $\frac{1}{4}$ division. The amount that a regulator is rotated can be easily gauged by reference to the dot on the top of each cup.

In order to allow greater latitude for regulation, either one or both of the regulators can be rotated in making a correction; for example, a correction of 4 seconds per day can be made either by rotating one regulator 2 divisions, or by rotating each of the regulators 1 division.

Since there are 7 divisions on each of the regulators, and since each division is equal to 2 seconds per day, it would be impossible to make a correction of more than 28 seconds per day, even if both regulators were originally set all the way in one direction (which they will not be).

how to regulate

1. Open case (page 10, steps 1 through 4).
2. With a pegwood stick, rotate one or both of the regulators (see Fig. 7) a sufficient number of divisions and in the direction necessary, to make the required correction. Rotating a regulator *away* from the center of the movement will cause the ACCUTRON timepiece to run *slower*; rotating a regulator *toward* the center of the movement will cause it to run *faster*.
3. For reassembly following regulation, refer to page 27, steps 2 thru 7.



TO REGULATE 2 SECONDS PER DAY SLOWER, MOVE EITHER REGULATOR ONE DIVISION OUTWARD AS SHOWN.



TO REGULATE 2 SECONDS PER DAY FASTER, MOVE EITHER REGULATOR ONE DIVISION INWARD AS SHOWN.



OBSERVE THE SEVEN "DIVISIONS" ON EACH REGULATOR

Fig. 7

checking electronic circuit

The ACCUTRON movement itself is your test fixture, and the best means of testing electrical and mechanical capabilities. Testing the electronic circuit requires you to:

1. Take the movement out of the case (refer to page 10). Inspect for and eliminate mechanical overloading and/or obvious tuning fork blockage.
2. Place the movement, dial side down, in the Movement Holder with the Power Cell recess adjacent to the notch in the side of the holder. On some models the dials and hands will have to be removed.
3. With a Power Cell in the nest of the Test Set, connect the spring clip at the end of the lead to the movement so that the center finger (+) is touching the contact in the center of the Power Cell recess. The other two fingers (-) should be spring tight in the pillar plate (see Fig. 3).
4. Turn the Test Set rotary switch to "READ MICROAMPERES" position. The Power Cell is now connected to the movement through the Test Set and the meter will give a reading of current on the left-hand scale. (It may be necessary to tap the movement lightly to start the tuning fork vibrating after connecting the spring clip.) The current reading should be in the "OK" area of the scale (4.5 to 7.0 microamperes).
5. If the movement is warmer than room temperature — as a result of exposure to the direct rays of the bench lamp, or from being held in the hand — this may cause a higher than normal current. If the reading is slightly higher than the "OK" area, let the movement sit for $\frac{1}{2}$ hour at room temperature, away from the direct rays of any lamp, and again check the current.

NOTE: Mechanical interference, caused by improper adjustment and/or any factor (such as lint) which restricts or work-loads the fork may also result in abnormal Test Set readings. Unless the circuit is "open" (current reads zero), it is rarely necessary to replace the Coil Assembly during repair on ACCUTRON. If the tuning fork vibrates, an ACCUTRON problem is not due to a faulty Coil Assembly. Higher than normal current, variable current, irregular timekeeping, etc., are (with very rare exception) always caused by other factors.

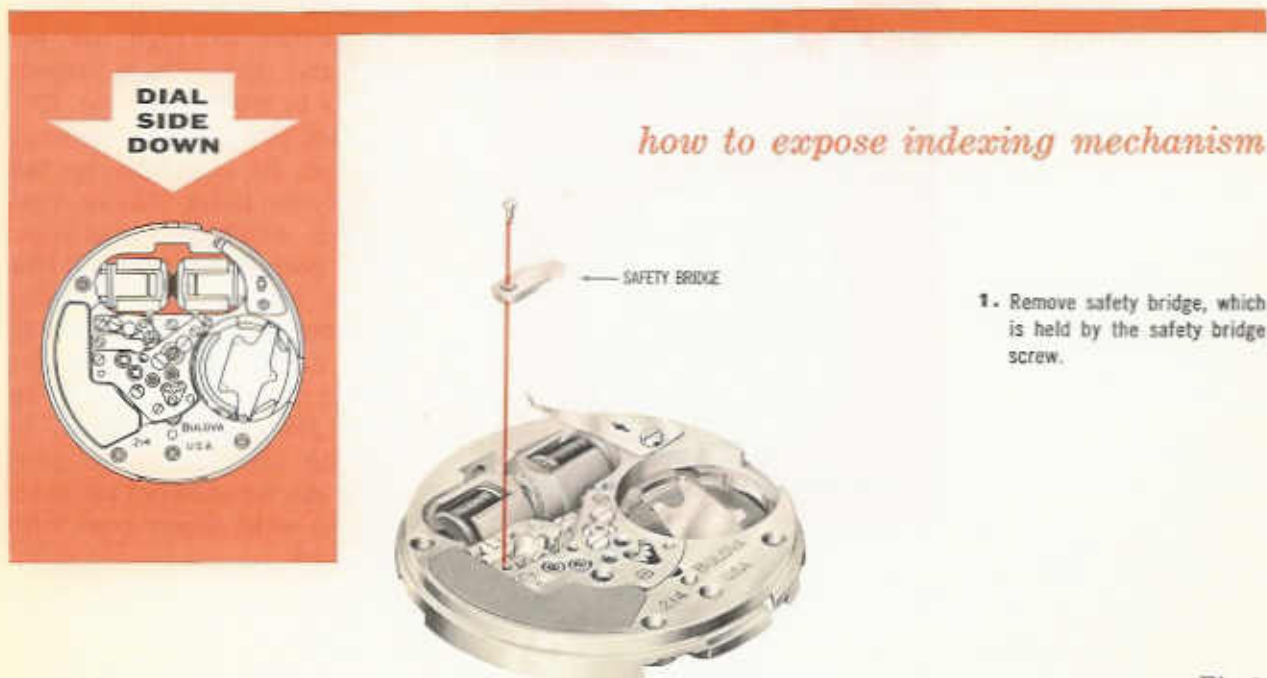

Fig. 8

indexing mechanism — inspection and adjustment

THE CHECKING OF THIS MECHANISM SHOULD NOT BE ATTEMPTED WITHOUT THE USE OF A SUITABLE MICROSCOPE. A LOUPE, EVEN OF HIGH POWER, IS NOT SUITABLE FOR THIS PURPOSE.

The checking and adjustment of the ACCUTRON indexing mechanism is extremely important to its operation. This is accomplished by closely controlling the alignment and the depth of engagement of the index and pawl jewels and their interrelation. First, the alignment of both jewels is checked and, if necessary, adjusted. Then, the engagement of the index jewel is checked and, if necessary, adjusted. Finally, the interrelation between the two jewels is adjusted.

Details of the step by step procedure necessary to properly accomplish these adjustments are to be performed in sequence, as follows:

1. Loosen index guard screw, and turn index guard away from index wheel. Do not remove, just turn out of the way, being careful not to damage index and pawl fingers, which run through the guard. Tighten screw (see Fig. 9).
2. Looking at the movement under the microscope, make sure that pawl jewel is engaged with index wheel. (The pawl jewel must be engaged with the wheel, so that during the check for engagement of the index jewel — Step 4 below — the wheel will not back up.) If it is not engaged, rotate pawl bridge cam until pawl is brought in contact with wheel.

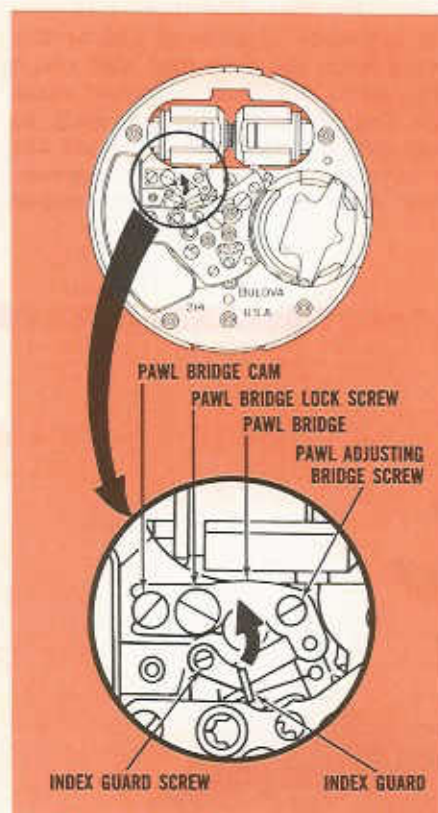

Fig. 9

3. Under the microscope, check to be sure that each finger is straight, that both jewels are centered on wheel (that both are neither too high nor too low) and that each is perpendicular to wheel (see Fig. 10). If index jewel is not centered, this can be corrected by the use of the Index Finger Post Wrench, which fits on the index finger post (located on one tine of the tuning fork). Placing the wrench over the end of the post, *gently* stress it in the proper direction to center the index jewel on the wheel, by bending the post. The pawl jewel can be centered by bending the pawl finger post with tweezers.

If either jewel is not perpendicular to the plane of the wheel (Fig. 10), this can be corrected by grasping the jewel finger (and stress limiter) close to the point where it is pinned, with tweezers (be careful not to touch the jewel itself) and twisting slightly.

Observe the stress limiters on index and pawl fingers (see Fig. 10). Check that no more than $\frac{1}{3}$ of the length of the stress limiter is in contact with the index or pawl finger. Also, check that end of stress limiter is no more than 3 thicknesses of the stress limiter away from index or pawl finger. If adjustment is necessary, use tweezers to bend stress limiter.

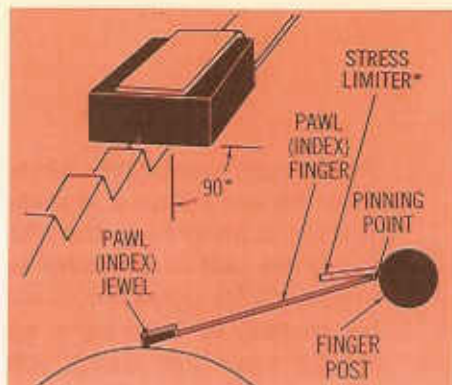

Fig. 10

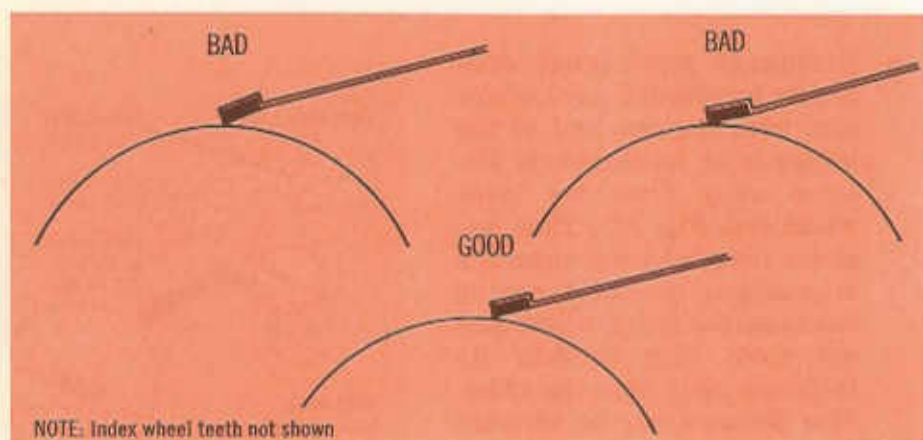

Fig. 11

The lower surfaces of the index and pawl jewels must be parallel to their respective fingers, as shown on Fig. 11. Correction of this alignment is rarely required. It can usually be accomplished, if necessary, without breaking the cement attaching the jewel to the finger by exercising considerable care. Grasp the finger proper with tweezers, close to the jewel, and press lightly on the end of the jewel (or index finger) in the proper direction with pegwood, to correct the alignment of jewel and finger.

4. Check the engagement of the index jewel by pulling back the tine of the tuning fork to which the index finger is attached (see Fig. 12). Count the number of teeth the index jewel "drops off" before index jewel pulls away from the wheel (see Fig. 13). THE JEWEL SHOULD DROP OFF 5 TO 8 TEETH. If the number of teeth is smaller than 5 or greater than 8 the engagement can be modified by gently bending the



Fig. 12

* Stress limiter feature added in 1964.

index finger (and stress limiter) near the end where it is pinned, toward or away from the wheel, using the end of tweezers or a needle. (This operation is similar to that of bending a hair-spring near the stud.) After this adjustment, the engagement should be rechecked (see Fig. 13).

5. Loosen pawl bridge lock screw slightly; leave pawl bridge pivot screw tight.

6. Disengage pawl jewel completely by rotating pawl bridge cam until the cam end of the bridge is at its *maximum* distance away from the index wheel (see Fig. 14). Then, examine the pawl jewel under the microscope; it should not be touching the index wheel, and not more than one-half its thickness away from the wheel. This distance may be adjusted by pressing gently in or out on the pawl finger, as described above in adjusting the index jewel engagement.

7. With the Power Cell in the nest on the Test Set, turn the rotary switch to the "LOW AMPLITUDE" position. Attach the Test Set to the movement with the spring clip (see page 4, Fig. 3). When the spring clip is attached to the movement the fork should begin to vibrate. If it does not, this will be indicated by an excess current reading on the meter of the Test Set. Should this occur, tap the movement lightly, and the fork will start, decreasing the current reading to the lower end of the "OK" area, or slightly below.
8. Rotate the cam very slowly in either direction (since it was at its maximum distance away, rotating either clockwise or counterclockwise will move the pawl toward the wheel) until the movement begins to run. This can be seen without the microscope, merely by watching the wheels that are visible. Turn the cam farther in the same direction until the train stops, and then continue still farther until you reach the point where it starts again and continues to run (momentary hesitation permissible).

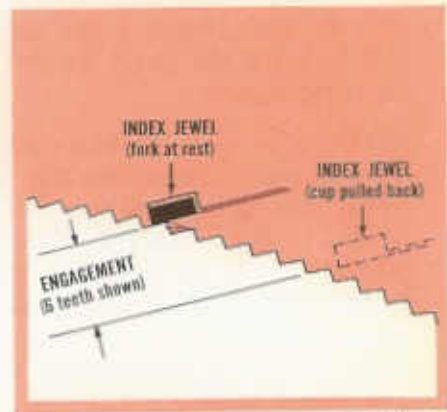

Fig. 13

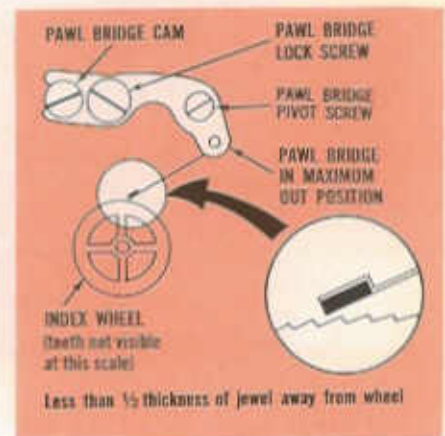

Fig. 14

9. With Test Set at "low amplitude" tighten pawl bridge lock screw and check the tightness of the pawl bridge pivot screw, to assure that the bridge is rigidly clamped in position. The ACCUTRON train should continue to run. If it does not, the adjustment must be made again. At this point the adjustment is complete.
10. Disconnect the Test Set spring clip from the movement.
11. Loosen index guard screw, and turn index guard back into position, being careful not to damage the index finger or pawl finger. Tighten screw. Using the microscope, tip the movement into a suitable position and observe the clearance between the index finger and the guard. With the guard in position, the index finger should pass through a point slightly inside the center of the slot in the guard (see Fig. 15). The index finger should not touch either side of the slot. If it does, bend the guard up or down slightly to center the index finger, making sure also that the pawl finger does not touch the guard.

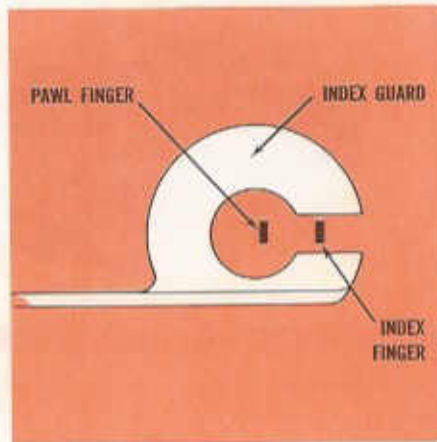

Fig. 15

12. Replace safety bridge and safety bridge screw.

checking the train for freedom

This check is used in the procedures described in the Servicing Table, to determine whether there is any mechanical blockage of the gear train.

The freedom of the train could be checked by simply moving one of the gears with a tweezers or needle, but there is danger of damaging the index and pawl fingers or the index wheel teeth. Thus, the safest and most convenient method of checking the train freedom is to pluck, or "twang" the tine of the tuning fork to which the index finger is attached. When this is done, the fork will vibrate for a few seconds and this motion will be transmitted to the train—if it is not blocked.

The motion of the train can easily be seen, with a loupe or the microscope, by watching any of the gears at the time that the fork is being plucked.

If no motion of the gears is apparent when the fork is plucked, this is evidence of a blocked train, assuming that the indexing linkage has already been checked, as is called for in the Servicing Table procedures.

PROCEDURES FOR DISASSEMBLY

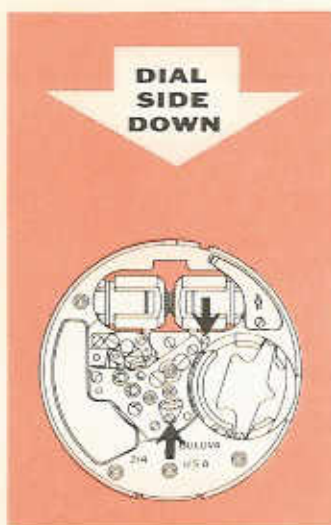

how to remove hands, dial, and dial train



1. Remove ground strap so movement can be placed in holder.
2. Remove the two dial holding nuts. Exact location is shown.

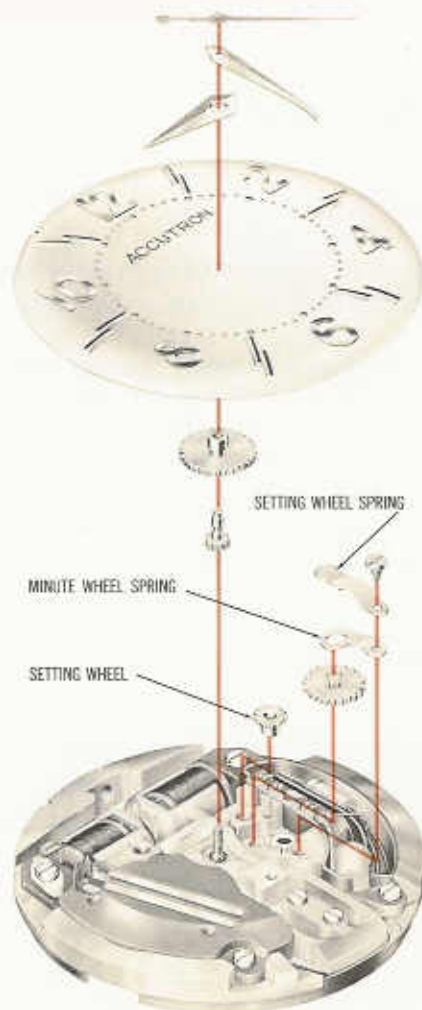

1. Remove hands, using hand remover.
2. Remove dial.
3. Remove hour wheel.
4. Remove cannon pinion.
5. Remove setting wheel spring, and minute wheel spring which are held by one setting wheel spring screw.
6. Remove minute wheel.
7. Remove setting wheel.

CAUTION: Do not turn second center pinion forward, or force it backward, in replacing hands, as this will damage the indexing mechanism.

**DIAL
SIDE
DOWN**



INDEX GUARD
SCREW

**DIAL
SIDE
UP**

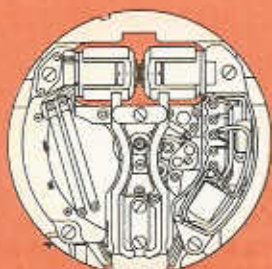

**DIAL
SIDE
DOWN**



how to remove coil and fork assembly



1. Place dial down on movement holder and remove safety bridge (See Fig. 8, page 13).

2. Loosen index guard screw, and turn index guard away from index wheel. Do not remove, just turn out of the way, being careful not to damage index and pawl fingers, which run through the guard. Tighten screw.



3. Place dial up on movement holder.

4. Remove shock bridge, which is held by one shock bridge screw.

5. Remove the two tuning fork screws.

6. Place dial down on movement holder.

7. Using a metal punch, tap on the base of the tuning fork through hole provided in pillar plate until fork is disengaged.

8. Pick up movement and holder and invert so that the movement is on the bottom. Remove holder and place it under the movement.



how to remove coil and fork assembly (cont'd)

DIAL
SIDE
UP

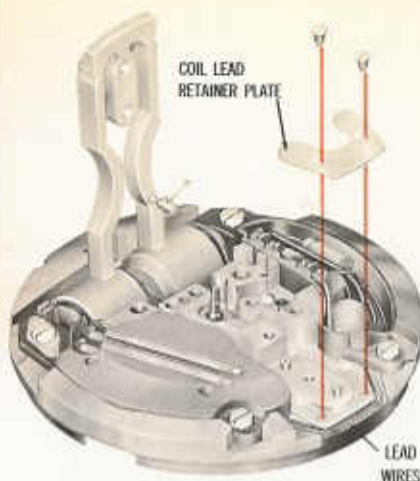
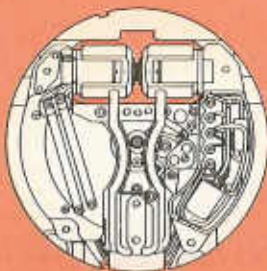

9. Lift fork at the base and rotate upward carefully until it is self-supporting in a vertical position.
10. Remove the coil lead retainer plate, which is held by two screws.

CAUTION: USE EXTRA SPECIAL CARE WHEN REMOVING THIS SCREW IN ORDER NOT TO DAMAGE THIS WIRE ON ADJACENT TIE POINT.

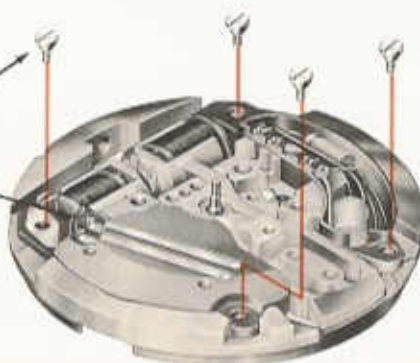

11. Lower fork carefully, but do not force down.
12. Remove the four coil form screws.
13. Without turning over the movement, remove the holder from the bottom. The nested side of the holder as illustrated in Fig. 2 is now placed over the movement and rotated until the locating key of the movement holder engages the notch at the edge of the pillar plate. Invert the complete assembly. Make sure pillar plate is firmly seated in the movement holder.

DIAL
SIDE
DOWN



14. Use pegwood stick to push down on coil assembly at several points, disengaging the coil and fork assembly from the pillar plate. The nested holder is designed to receive the tuning fork and coil assembly without permitting the index finger to touch the opening in the pillar plate during removal.
15. The movement can then be removed from the holder. The coil and fork assembly should be left in place in the movement holder unless it is necessary to remove for cleaning or replacement, in which case the coils can be disassembled from the fork by gently spreading the coils apart.

In some movements the coil lead retainer plate is not used. In this case, the procedure for removal of the coil and fork assembly is much simpler—merely perform the above steps in the following order: 1, 2, 3, 4, 12, 5, 6, 7, 14, 15.

CLEANING

The following additional disassembly steps should be performed *only* when cleaning is necessary:

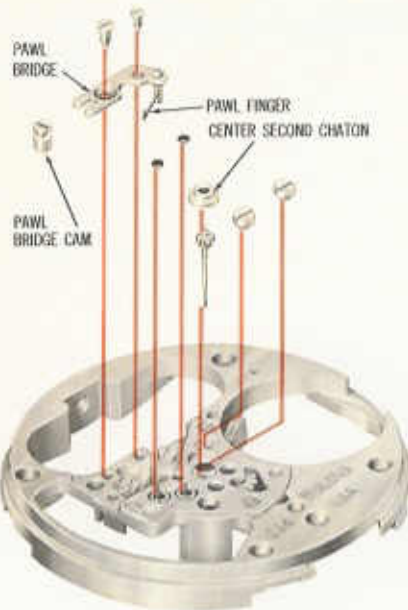
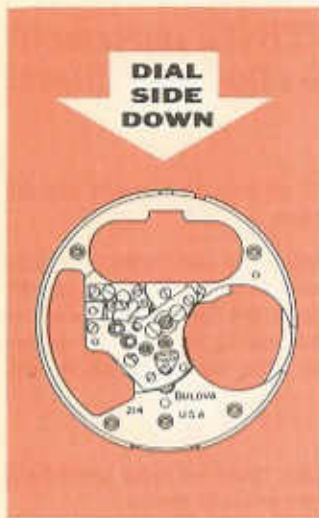

1. Remove pawl bridge and finger assembly by removing two screws. The pawl bridge cam is not threaded and will come out with the bridge. Care should be taken not to bend the pawl finger.
2. Remove the two Duofix cap jewels by applying horizontal pressure to the closed side of the U-shaped spring, allowing the lip of the spring to emerge from under the bezel. The spring can then be tipped up, and the cap jewel removed. After the jewels have been removed, the springs should be re-engaged to prevent their loss in cleaning.
3. Remove center second chaton, which is held by two chaton screws.
4. Remove center second pinion and washer by grasping with tweezers and lifting out through hole in train bridge.

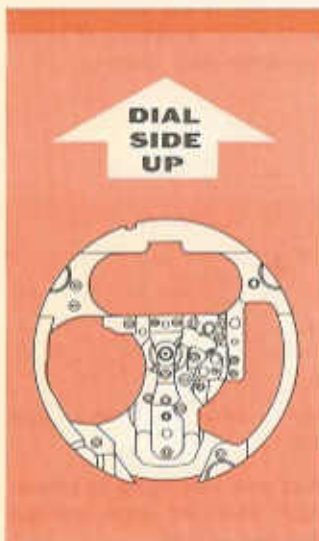

1. Remove lower jewel plate, which is held by one screw.

disassembly of the wheel train is unnecessary under ordinary conditions

Ultrasonic equipment is necessary for cleaning the ACCUTRON movement. It should be treated exactly as any fine watch, with one exception. The electronic circuit, the tuning fork, and the pawl adjusting bridge *should not be cleaned in ultrasonic equipment*, because of the possibility of danger to delicate parts.

The fork, coil, and pawl bridge can be cleaned satisfactorily by merely dipping into a "benzine cup" and then placing on a tissue to dry.

Care should be taken to prevent metal chips, which may be present in the cleaning cup or on the bench, from being attracted to the permanent magnets on the tines of the tuning fork. Inspect the fork carefully after cleaning, and if this has occurred, any particles that are clinging to the magnets can be removed with masking tape. No particles should be left adhering to fork magnets.

OILING

following cleaning, the ACCUTRON movement should be oiled as follows:

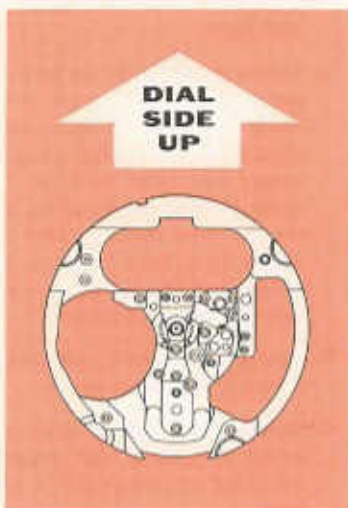

1. Oil all train wheel pivots and cap jewels.
2. Using small oiler, lightly oil surface between center wheel slip clutch* spring and center wheel, also between spring and steel hub on center arbor (see illustration at left).

CAUTION: Never oil index wheel teeth (or index and pawl jewels).

*ACCUTRON movements of very early manufacture lacked this slip-clutch construction. It was later introduced to avoid critical adjustment of cannon pinion—center arbor friction.

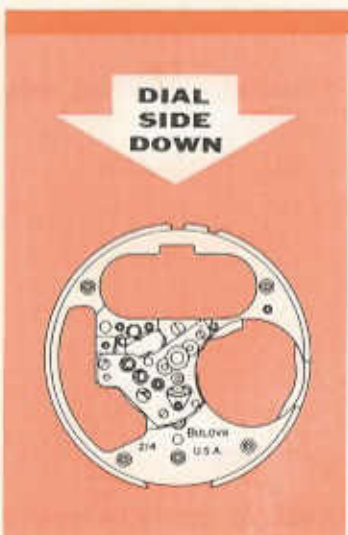

3. Depress center wheel with pegwood stick.
4. Using small oiler, lightly oil between center wheel and clutch face (see illustration at left).

CAUTION: Be careful not to oil center bridge. If oil first touches center bridge, it will remain on bridge and clutch face will not be oiled.

PROCEDURES FOR REASSEMBLY

following oiling, reassemble as follows:

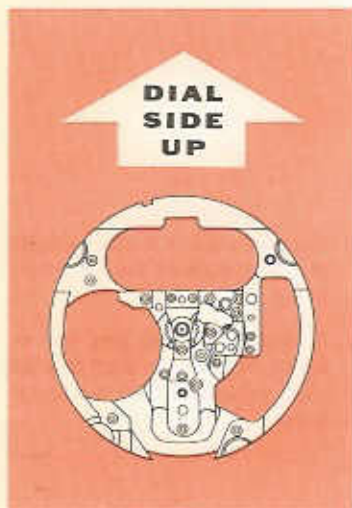

1. Replace lower jewel plate.

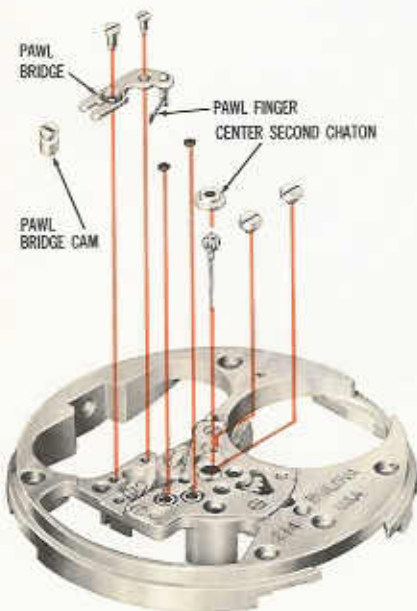
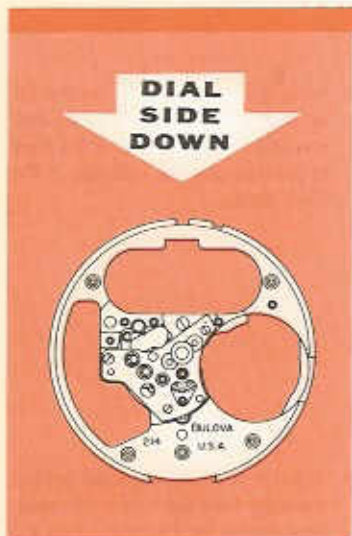

1. Replace center second pinion and washer.
2. Replace center second chaton and its two screws.
3. Replace the two Duofix cap jewels by disengaging the lip of the spring from the bezel, allowing the spring to tip up. The jewel can then be placed under the spring and the lip re-engaged.
4. Replace pawl bridge cam. (Do not push all the way in!)
5. Slide forked end of pawl bridge under head of cam and position pawl adjusting bridge, being careful not to damage pawl finger. Replace the two screws.



replacement of coil and fork assembly



1. Place coil and fork assembly into the prepared slots in the movement holder.
2. Position pillar plate over the assembly, making sure notch in pillar plate engages key in movement holder.



3. Holding movement holder so that pillar plate will not drop out, turn over and press through holes in the back to partially seat the assembly in the pillar plate.
4. Transfer pillar plate and coil and fork assembly from one side of the movement holder to the other placing it in the dial-side-up position.

DIAL
SIDE
UP



replacement of coil and fork assembly (cont'd)

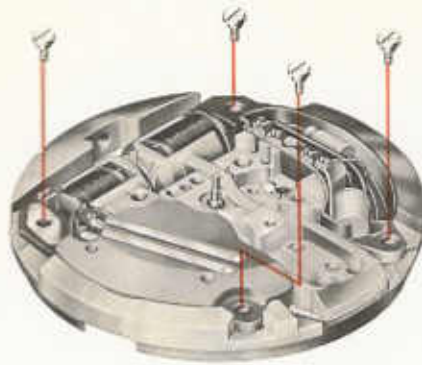

5. Press down firmly on coil form only, to make sure it is completely and evenly seated in pillar plate.
6. Replace the four coil form screws.

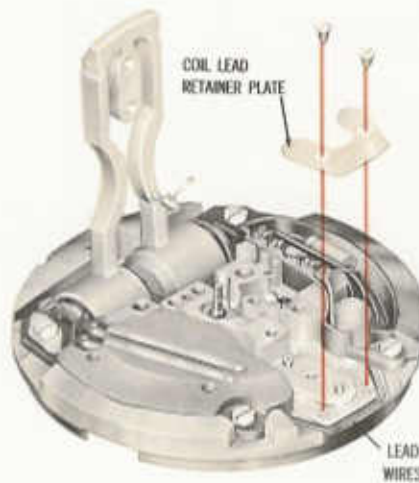

7. Lift base of fork to the vertical position and replace coil lead retainer plate and screws.
8. Check position of the lead wires to make sure that the delicate insulation will not be damaged when coil lead retainer plate is screwed down.
9. Lower fork carefully and press firmly into place. Care should be taken to apply pressure only at the tongue of the fork; avoid contact with the tines.

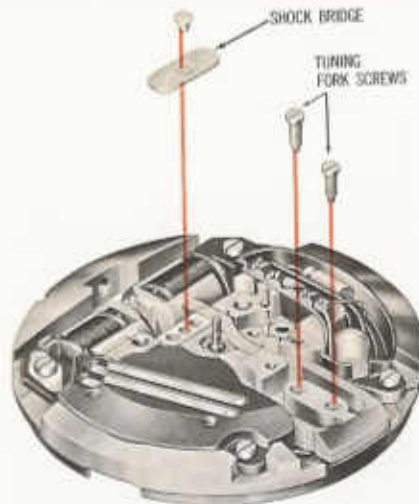

10. Replace the two tuning fork screws.
11. Replace shock bridge and shock bridge screw. Check to see that fork is free to vibrate — that the coils fit into the cups on the end of the tines without touching, and that nothing is in contact with the tines at any point.

In models that have no coil lead retainer plate, the above steps should be performed in the following order: 1, 2, 3, 4, 5, 6, 8, 10, 11. Also in step 8, make sure the three lead wires do not touch base of fork.

DIAL
SIDE
UP

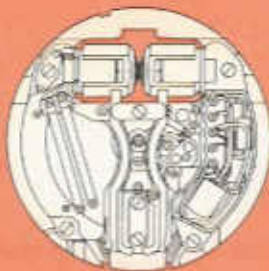

replacement of dial train, dial and hands

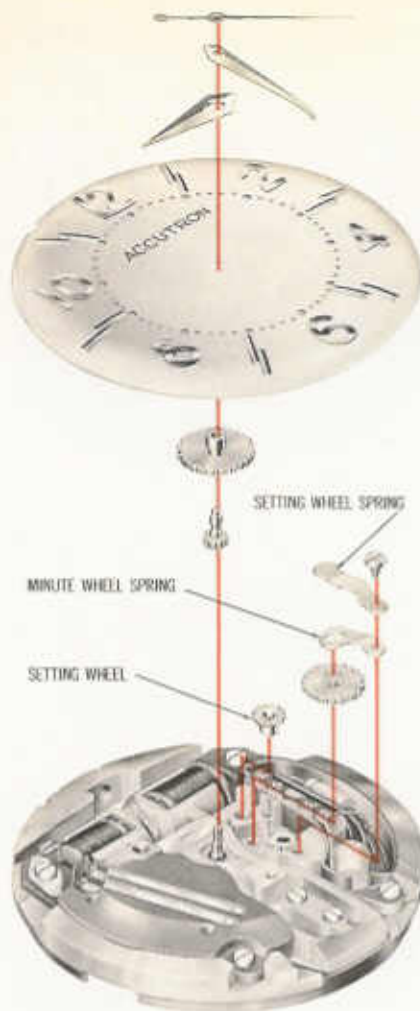

1. Moisten center pinion staff with oil, and replace cannon pinion.
2. Replace setting wheel.
3. Replace minute wheel.
4. Replace setting wheel spring, minute wheel spring and setting wheel spring screw.
5. Replace hour wheel.
6. Replace dial.*
7. Replace hands.

CAUTION: Do not turn second center pinion forward, or force it backward, in replacing hands, as this will damage the indexing mechanism.

DIAL
SIDE
DOWN



1. Replace the two dial holding nuts.*
2. Replace ground strap and screw.
3. Check that tip of ground strap is 2 to 3 mm. above surface of pillar plate. Adjust if necessary.
4. Replace safety bridge.

**For simplicity of presentation the procedure of adding hands has been combined with other dial side operations. In practice always replace dial holding nuts before hands.*

casing the movement

1. Replace movement in case.
2. Replace gasket.
3. Replace back, using care to insert the end of the setting stem into the hole provided, as indicated in the illustration. As an aid in correct reassembly, note that the back is provided with a locating tab or key that fits into a corresponding notch in the case.
4. Rotate the crown at least a half turn to ensure that the square end of the setting stem engages with the hole in the setting wheel.
5. Put setting handle down.
6. Replace locking ring and tighten with wrench.
7. Check for water resistance before returning to customer.

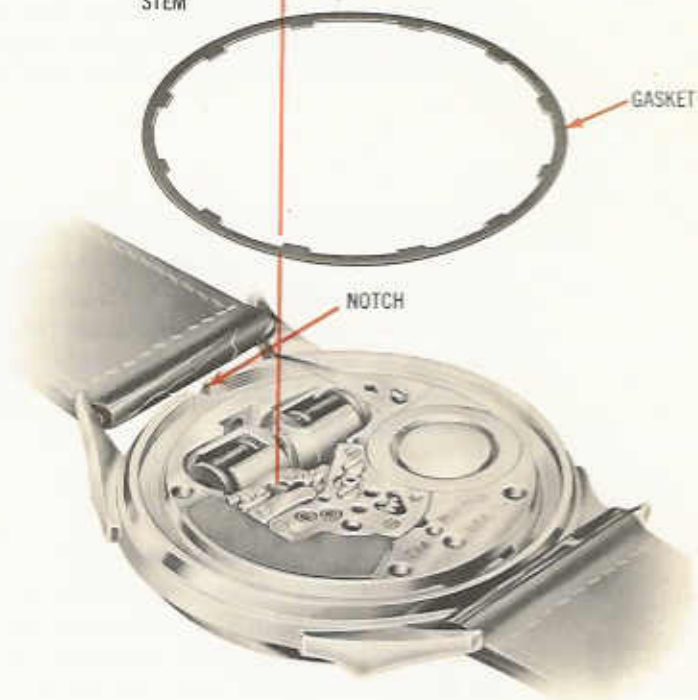
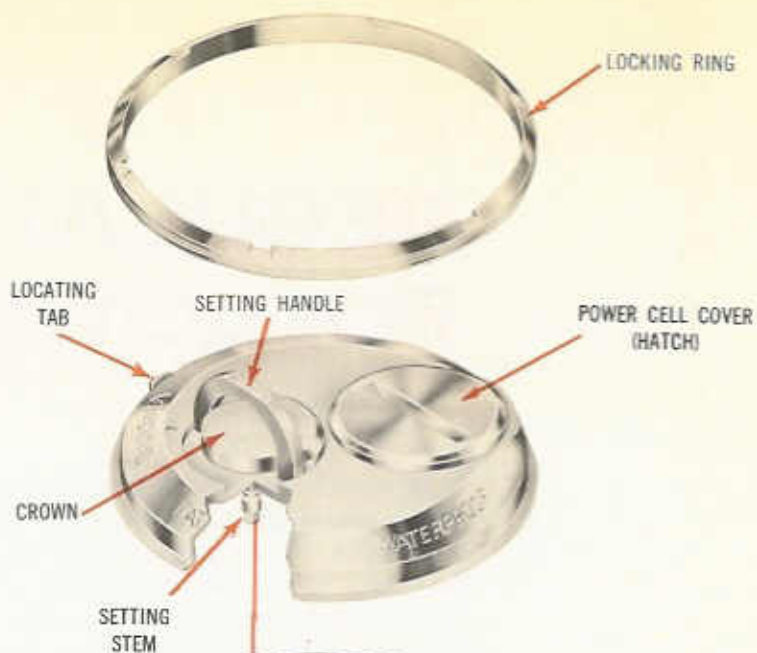

REGULATION FOLLOWING REPAIR

It is readily possible to return a repaired ACCUTRON timepiece to the owner pre-regulated to keep time within one minute per month, with rare exceptions, if the proper facilities are available. This requires that the timepiece be adjusted to *lose* two seconds per day in the dial up position, for optimum performance when the owner wears it in a normal manner on the *outside* of the wrist. When the owner wears it on the *inside* of the wrist, the ACCUTRON timepiece should be regulated to *gain* two seconds per day in the dial up position, for optimum performance in actual use.

If the ACCUTRON repairman has access to a source of *exact* time, checking the 24-hour rate of gain or loss of a repaired ACCUTRON timepiece is relatively simple. In this instance, after casing the movement, it is set approximately on time and its deviation from precise time recorded to the nearest $\frac{1}{2}$ second. After allowing it to run dial up for 24 hours, it is again compared with the time signal and the amount gained or lost recorded to the nearest $\frac{1}{2}$ second.

The difference between the observed rate and -2 seconds per day (for wearing on the outside of the wrist) having now been established, the calibrated regulators can be employed to make the necessary correction in rate (see Page 12). The effectiveness of the correction should preferably be checked by again determining the 24-hour rate in the dial up position. Obviously, deviations of a second or so per day from the optimum rate can be allowed, to provide timekeeping within the desired minute per month specified in Bulova's guarantee.

The difficulty in obtaining time which is accurate to the second, as required for the above procedure, is not always recognized by the watchmaker. Conventional synchronous electric clocks are sufficiently accurate for checking conventional watches but may vary throughout the day from several seconds fast to several seconds slow. They are therefore unsatisfactory for checking the true 24-hour rate of ACCUTRON. The Western Union clocks, used in many jewelry stores in the United States, are similarly unsatisfactory for checking the 24-hour rate of ACCUTRON timepieces. These

clocks are automatically corrected hourly from a "master" clock which is manually set to a time signal provided once each day by the U.S. Naval Observatory. While they are always approximately correct, errors as great as 15-30 seconds are relatively common. The hourly "beeps" broadcast by some radio and television stations are not necessarily correct to the second and should not be used for checking the exact performance of ACCUTRON timepieces.

There are a few areas in the United States where a precise time signal, accurate to the second, is available from the telephone company. Except when such signals are available, accurate time for checking and regulating ACCUTRON timepieces can best be obtained with a short-wave radio receiver. Such a receiver can be used to receive the precisely controlled time signals broadcast continuously from government-operated short-wave radio stations.

A special Rate Recorder provides the most satisfactory solution to the problem of regulating an ACCUTRON timepiece following repair. The repair and checking procedures covered in the preceding sections will assure that the hands will turn in exact synchronism with the vibrations of the tuning fork. Measuring the tuning fork rate will therefore indicate the amount the ACCUTRON timepiece will gain or lose in 24 hours. This measurement of tuning fork rate is readily made with a Rate Recorder having a special signal pick-up device and circuitry for printing a clear record, together with a very precise internal frequency standard. A Rate Recorder suitable for timing the ACCUTRON timepiece is available from WATCHMASTER Products Division of Bulova Watch Company.

Regulating a repaired ACCUTRON timepiece to the required rate (-2 seconds per day dial up) is a very obvious procedure, using the Rate Recorder and the ACCUTRON calibrated regulating system. Rate measurements should be made only with the case tightly closed. Also, it is good practice to allow the timepiece to "settle" for an hour or more after last closing the case, before making the final Rate Recorder measurement of its rate. This avoids the small changes in rate which may occur immediately after casing as a result of trapped air, etc. (See page 32, "rate recorder.")

INFORMATION AND HINTS FOR THE ACCUTRON REPAIRMAN

equipment

DO NOT ATTEMPT TO SERVICE THE ACCUTRON MOVEMENT (OTHER THAN REGULATION OR POWER CELL REPLACEMENT) WITHOUT A SUITABLE MICROSCOPE AND THE ACCUTRON TEST SET, CONTAINED IN THE REPAIR KIT.

exchanging movements to correct a problem

Bulova does not recommend exchange of movements to solve a customer's problem. The ACCUTRON movement, unprotected by the case, can be readily damaged or its functioning seriously disturbed. The repairman who lacks the necessary equipment and knowledge to diagnose and repair the trouble with an ACCUTRON movement can rarely satisfy the customer by switching movements. This usually results in two problem movements and one *very* dissatisfied customer.

irregular timekeeping

Reports of irregular ACCUTRON timekeeping, where the timepiece appears to jump fast one day, then slow the next, are almost certain indication that the timepiece was checked against an inaccurate time "standard." See discussion on Page 28. *Always be sure the true nature of the customer's problem is understood before attempting to correct it by repairing the movement.*

power cell cover contact spring

Before attempting movement repair, always examine the contact spring on the Power Cell cover to be certain it makes good electrical contact with the Power Cell. These springs are occasionally damaged by carelessness during Cell replacement, causing a problem which for obvious reasons cannot be corrected by movement repair.

cleaning

The practice of cleaning a watch, as a routine part of nearly every repair, results from the watchmaker's knowledge that optimum performance and reliability can be expected only when lubrication is fresh. The performance of ACCUTRON is relatively unaffected by the condition of the lubrication. Cleaning will not usually be required to restore an ACCUTRON timepiece to proper operating condition.

oiling

The instruction to oil sparingly is repeated here for emphasis. Flooding the various bearings can result in oil running onto the teeth of the index wheel. In this instance, oil attracts and holds any dirt or foreign matter in the case, which may then interfere with proper operation of the indexing mechanism. This trouble is rarely experienced if the bearings are oiled properly.

removing and replacing the tuning fork

The tuning fork should *never* be pried up, during removal, by inserting a screwdriver or other tool under the tines. This practice will "bruise" the tines and permanently affect the tuning fork rate—usually requiring replacement with a new tuning fork to restore timekeeping. Use the "knock-out" hole provided, to push the mounting tongue off the two dowels.

In removing and replacing the tuning fork and coil assemblies, use care to avoid damaging the insulation on the connecting wires which pass under the base of the tuning fork.

index wheel endshake

Insufficient endshake of the index wheel pinion in its bearings can cause the index wheel to fail to "draw" back reliably after each operation of the indexing mechanism. This results in the timepiece gaining excessively. While this condition is rare, it is good practice, whenever checking the movement, to perform the simple check which will detect it. With the movement running on the Movement Holder, attached to the Test Set, press on the index upper endstone cap jewel with pegwood. If there is no endshake, the slightest pressure on the cap jewel will cause a significant increase in the current.

functional check of setting mechanism

Gradually raise setting handle and turn the crown back and forth until minute hand moves, meanwhile observing the distance the crown lifts. Crown (not setting handle) should lift at least $\frac{1}{4}$ mm *before* setting wheel engages minute wheel and hands turn. If necessary, change to longer stem to correct inadequate clearance between setting wheel and minute wheel. Case part identification given on page 27.

check adjustment of indexing mechanism after dialing

It is *always* good practice to check the adjustment of the indexing mechanism *after* replacing the dial and hands. This is because the adjustment of the indexing mechanism can change as a result of the slightest turning of the center second pinion when the hand is applied.

magnets partially demagnetized

Diagnosis procedures in the preceding servicing instructions have not covered the identification of trouble caused by demagnetized tuning fork magnets, for reasons of simplification. Experience has shown that such trouble is very rare. If the movement current is within the "OK" area of the scale on the Test Set, the magnets are satisfactorily magnetized.

If the tuning fork magnets have lost most of their magnetism, the tuning fork will fail to vibrate and the Test Set will indicate a very high current—normally interpreted as due to a faulty electronic circuit. If the magnets have lost only a portion of their magnetism, the tuning fork may vibrate but the Test Set will indicate that the current is above the "OK" area of the scale. In each of these instances, if an excessively high current (and/or failure of the tuning fork to vibrate) cannot be corrected by replacing the complete coil assembly—try substituting a different tuning fork.

If the tuning fork magnets have been demagnetized—the fork must be returned to Bulova for remagnetizing.

rate recorder

The ACCUTRON hour and minute hands are steel. On some models, depending upon the length and design of these hands, the tuning fork rate changes slightly when the hands are near the tuning fork magnets. For this reason, it is good practice to set both hands in the lower portion of the dial before measuring the rate of an ACCUTRON timepiece with the Rate Recorder.

case gasket replacement

The gasket which seals the water resistant case is serrated to provide a definite amount of cushioning for the ACCUTRON movement in relation to the case. Never substitute a conventional (non-serrated) water resistant gasket if the original gasket should require replacement.

crystal replacement

Whenever an ACCUTRON timepiece is received for repair with the crystal missing, always check the adjustment and operation of the indexing mechanism, which could have been deranged by any interference with the exposed sweep second hand.

exchanging dials

Interchange of dials to satisfy a customer's request for a non-standard combination of ACCUTRON dial and case is hazardous. Dial curvatures and bezel openings vary from style to style and different dials are therefore not necessarily interchangeable.

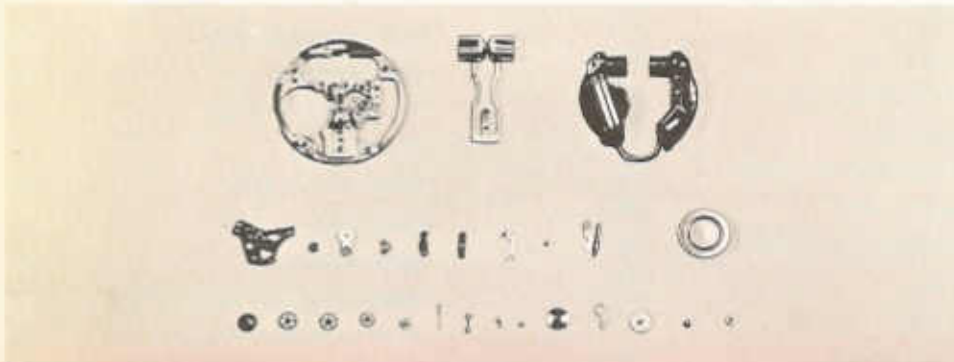

ACCUTRON
(screws not shown)

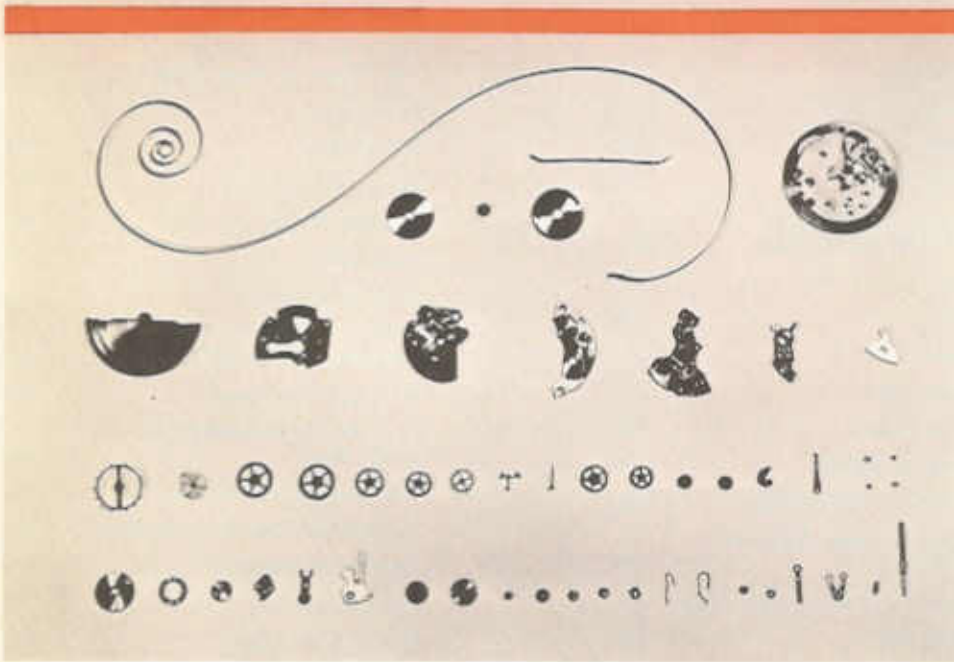

Self-winding movement
(screws not shown)

*comparison of **ACCUTRON** with self-winding movement*

PARTS LIST

Description	Part No.	Description	Part No.
Cannon Pinion	108	Minute Wheel and Pinion	111
Cap Jewel for Top Bushing for Index Wheel and Second Wheel	159.B	Minute Wheel Spring	192
Center Bridge	413	Pawl Bridge and Finger Assembly	180
Center Bridge Screw	131	Pawl Bridge Pivot Screw	184
Center Second Brake Spring	121	Pawl Bridge Cam	182
Center Second Hand	140	Pawl Bridge Lock Screw	181
Center Second Pinion and Washer	158	Pillar Plate	709
Center Wheel and Arbor	109	Power Cell (214 only)	162
Chaton for Center Second Pinion	157	Safety Bridge	214
Chaton Screw	156	Safety Bridge Screw	184
Coil Form Screw	151	Screw for Coil Lead Retainer Plate	191
Coil Lead Retainer Plate	190	Screw for Setting Wheel Spring	123
Complete Coil Assembly	711	Second Wheel and Pinion	103
Dial Holding Nut	148	Setting for Top Bushing for Index Wheel and Second Wheel	159.C
Fourth Wheel and Pinion	107	Setting Stem	176
Ground Strap	193	Setting Wheel	119
Ground Strap Screw	151	Setting Wheel Spring	120
Hole Jewel for Top Bushing for Index Wheel and Second Wheel	159.A	Shimming Washer	186
Hour Hand	143	Shock Bridge	113
Hour Wheel	110	Shock Bridge Screw	118
Index Guard	152	Spring for Top Bushing for Index Wheel and Second Wheel	159.D
Index Guard Screw	153	Third Wheel and Pinion	105
Index Guard Washer	154	Top Bushing for Index Wheel and Second Wheel	159
Index Wheel and Pinion	112	*Top Jewel for Center Wheel	165
*Lower Jewel for Center Wheel	166	Top Jewel for Third and Fourth Wheel	167
*Lower Jewel for Index Wheel and Second Wheel	170	Train Bridge (complete)	404
*Lower Jewel for Third and Fourth Wheel	167	Train Bridge Screw	125
Lower Jewel Plate	116	Tuning Fork Assembly	716
Lower Jewel Plate Screw	117	Tuning Fork Screw	183
Minute Hand	142		

Replacement spare parts can be ordered from your Bulova Material Distributor.

Damaged subassemblies (complete coil assembly, Part No. 711, or tuning fork assembly, Part No. 716) should be returned to Material Sales Division, Bulova Watch Company, Flushing, N. Y. 11370, for reconditioning.

*Not shown in illustration.

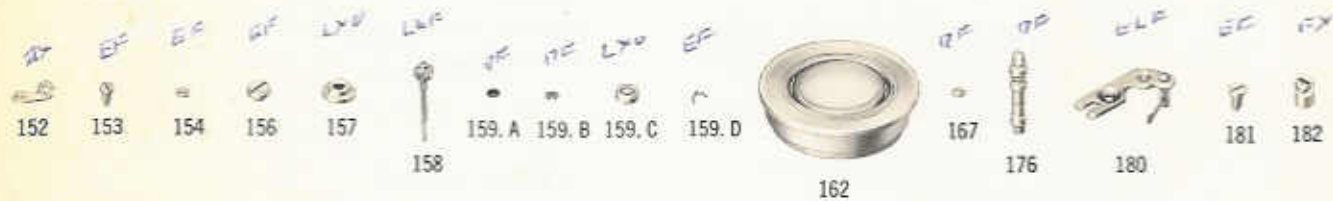

* Stress limiter feature added in 1964.

INDEX

A		M	
Accuracy of ACCUTRON	6, 11, 28	Mechanical components	1
Alignment, index and pawl jewels	14, 15	Microscope	1, 2, 14, 15, 17, 30
C		Movement holder	2, 4, 13
Case gasket replacement	32	O	
Casing movement	27	Oiling	8, 22, 31
Center second pinion	8	Opening case	10
Cleaning	21, 30	Operation of ACCUTRON	1
Cleaning equipment	5	P	
Coil and fork assembly		Parts list	34
removal	18	Power cell (214 only)	3, 7, 9
replacement	24	R	
Coil lead retainer plate	20, 25	Rate recorder	5, 29, 32
Correct time	28, 29, 30	Reassembly	24
Crystal replacement	32	Regulators, ACCUTRON	11
Current, electronic circuit	13	Regulation	11, 12
D		Regulation following repair	28, 29, 32
Demagnetizing	8, 32	Removing movement	10
Diagnosis	6	S	
Duofix cap jewels	21, 23	Service kit, ACCUTRON	2
E		Servicing table	7
Electronic circuit	13	Special tools and equipment	2
Electronic and electromagnetic components	1	Stress limiters	15
Engagement, index jewel	15	T	
Exact time	28, 29	Temperature, effects on current	13
Exchanging dials	32	Test set	2, 3, 9, 13
Exchanging movements	30	Testing procedures	9
G		Train, checking for freedom	17
Ground strap	26, 31	Tuning fork	31
H		Tuning fork amplitude	14
Hands, dial, dial train		Tuning fork demagnetization	8, 32
removal	18	U	
replacement	26	Ultrasonic watch cleaner	5, 21
Hints for repairman	30	V	
I		Voltage, power cell	9
Index finger post wrench	2, 5	W	
Indexing mechanism	1	WATCHMASTER products	5
checking after dialing	31	Wear	8
how to expose	13	Wheel train	21
inspection and adjustment	3, 14	L	
L		Locking-ring wrench	2, 5, 10

