

ACCUTRON®

Service Manual

Series 218

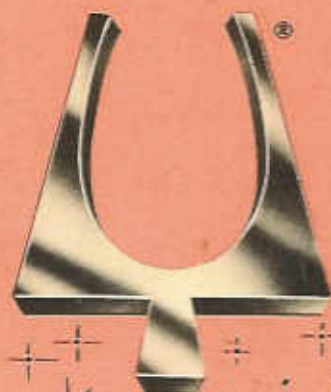

by **BULOVA®**

PATENT NOTICE

The ACCUTRON timepiece is manufactured by Bulova Watch Company, under issued patents as well as pending patent applications, including the following patents:

U. S.	2,886,582; 2,971,323; 3,162,006; 3,184,981; Re. 26209; 3,257,794; 3,221,190; 3,262,359; 3,421,310; 3,421,311
Canada	576,817; 609,691; 764,178; 756,819; 685,419
France	1,102,373; 74,802; 70,718; 1,491,231; 1,473,353; 1,322,145
Germany	971,659; 1,095,747; 1,124,433
Great Britain	761,609; 797,851; 840,086; 854,196; 855,559; 1,064,230; 1,074,104
Switzerland	312,290; 333,403; 342,171; 353,311
Italy	517,679; 558,253; 552,882; 591,162; 683,351
The Netherlands	228,637
Mexico	60,633; 59,196
Japan	249,402; 301,465; 485,526; 249,885; 246,248; 246,254

Table of Contents

	Page
To the Watchmaker	2
Part I —SERVICING PROCEDURES	3
Opening the Case	3
Replacing the Power Cell	4
Regulation	5
ACCUTRON* Regulators	5
How to Regulate	6
Removing Movement from Case	7
Replacing Movement in Case	8
Part II —REPAIR OF THE BASIC MOVEMENT	9
Special Tools and Equipment	9
ACCUTRON Service Kit	9
Cleaning Equipment	11
Rate Recorder	11
Diagnostic Chart	12-13
Special Points for the ACCUTRON Repairman	14
Indexing Mechanism—Inspection and Adjustment	15
Testing Power Cell	19
Testing Electronic Circuit	19
Identifying Defective Coil Assembly	20
Checking the Train for Freedom	20
Hack Mechanism—Inspection and Adjustment	20
Disassembly	21
Cleaning	30
Lubrication	31
Reassembly	32
Basic Parts List Series 218	40-41
Part III—REPAIR OF DATE MECHANISM IN MODEL 218D	42
Removing Hands, Dial, and Hour Wheel	43
Date Mechanism Disassembly	45
Date Mechanism Lubrication and Reassembly	45
Replacing Hour Wheel, Dial, and Hands	46
Parts List Model 218D	47
Index	48

MAY 24 1969

To The Watchmaker:

This Manual provides complete service and repair information for Series 218 ACCUTRON movements. Perhaps you already have experience in servicing the 214 ACCUTRON, for which there is a separate service manual. If so, you will find that while the repair and servicing procedures for 214 and 218 ACCUTRON movements are basically the same, there are physical differences between the two, primarily in the arrangement of parts.

Unlike the 214 ACCUTRON movement, the 218 movements can be repaired and adjusted without the use of a microscope. However, those experienced in servicing the 214 movement (and therefore having a suitable microscope available), will find the microscope very useful in checking and adjusting the 218 indexing mechanism.

Even if you have never serviced ACCUTRON, we would like to point out that the experienced watchmaker should be able to learn to service the 218 ACCUTRON movement in a matter of hours with the aid of this manual. Diagnostic procedures for locating and correcting faults are presented on pages 12 and 13. The first step in using these procedures is to establish the symptoms of the trouble. In many instances this information can be obtained only from the customer. Therefore, **WHENEVER POSSIBLE FIND OUT EXACTLY WHAT THE CUSTOMER'S PROBLEM IS BEFORE YOU ATTEMPT CORRECTION.**

For example, let us assume that an ACCUTRON timepiece has been brought to you because it is gaining or losing time. You must find out whether the gain or loss is **a few seconds a day or a minute or more a week** to determine whether it requires only simple regulation or whether the movement must be repaired. Suppose you are told only that "it loses" and your rate recorder indicates a loss of, say, 5 seconds a day. If you regulate it accordingly and return it, you will have a very dissatisfied customer if the timepiece was losing several **minutes** per day (requiring repair). On the other hand, the timepiece **may** have been losing several **seconds** per day, as shown by your rate recorder. In this case, if you elect to "repair" the movement, you are attempting to locate a defect or fault that does not exist. Such situations can only be avoided by finding out from the customer the symptoms that led him to bring the timepiece to you for correction.

Part I Servicing Procedures

Opening The Case

Use special locking-ring wrench.

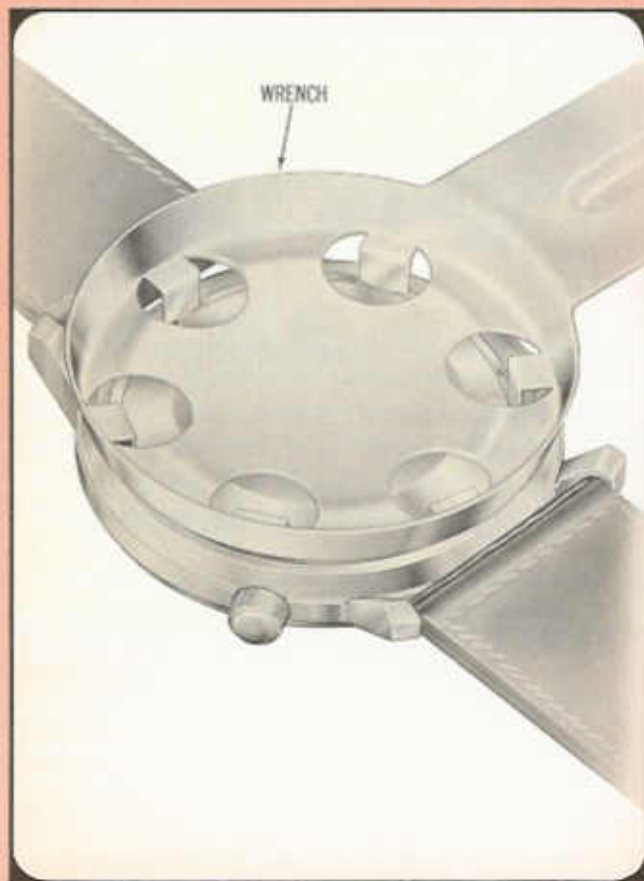

Fig. 1



Fig. 2

Replacing the 218 Power Cell

- a. Remove case back, using a suitable case wrench to unscrew the locking-ring.
- b. Loosen coil form screw slightly.
- c. Loosen cell strap hold-down screw, swing cell strap out and remove Power Cell as shown [see Fig. 3].
- d. Remove coil form screw (with insulator) and cell strap. Inspect (with loupe) under-surface of cell strap for foreign matter which may affect electrical contact with Power Cell. If necessary, clean with an eraser and dip-rinse.
- e. With the cell strap off, check that the insulating post of the cell coil assembly has not been damaged through improper installation of a Power Cell; attach cell strap by loosely installing coil form screw (with its insulator) through cell strap, making certain cell strap is correctly positioned around the insulating post of the cell coil assembly.
- f. Install the Power Cell with imprinted side down (see Fig. 3); reposition cell strap under the hold-down screw and secure screws.
- g. Check that case gasket is properly positioned; replace case back and tighten locking-ring.

Note: If sweep-second hand does not turn, be sure stem is in the normal or "in" position. If so, tap the case lightly at "3" or "9" to start tuning fork vibrating.

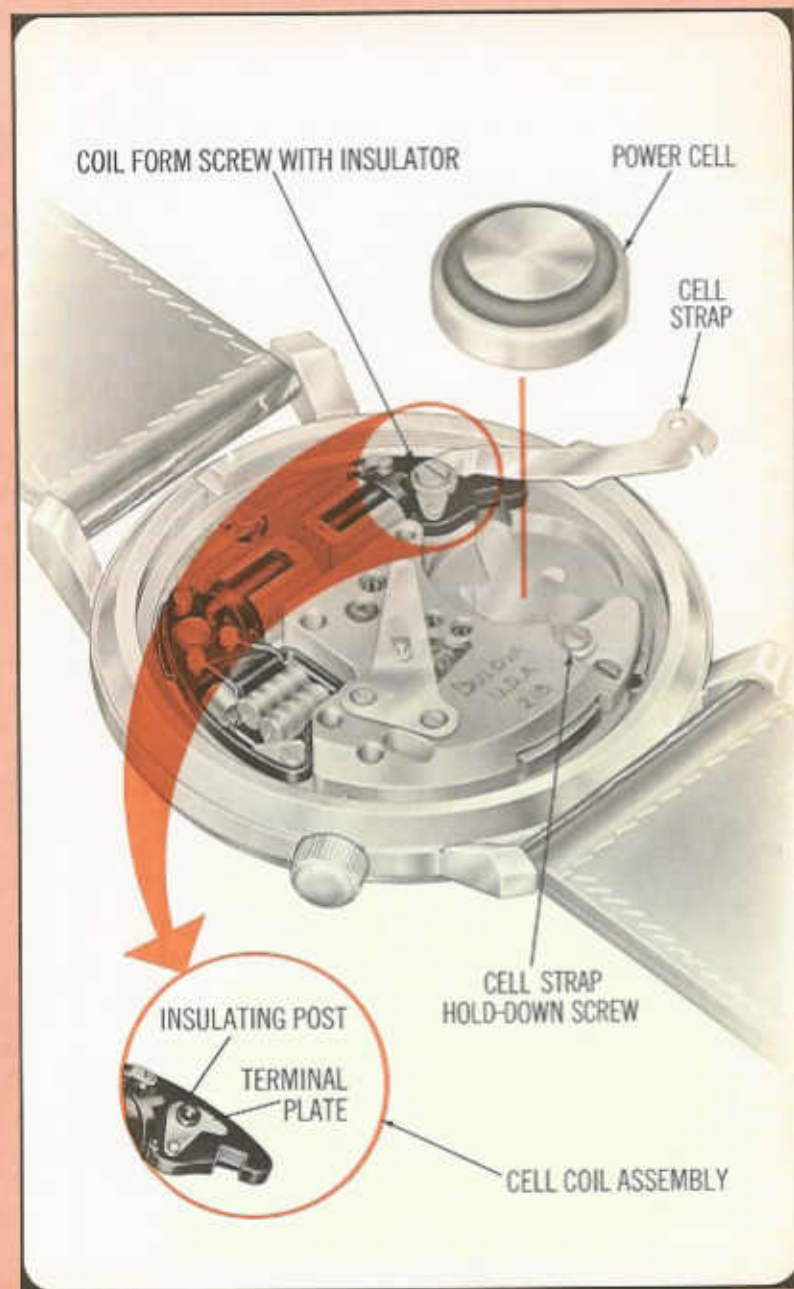

Fig. 3

Regulation

THE BASIC ACCURACY OF THE ACCUTRON TUNING FORK IS SUCH THAT REGULATION FOR MORE THAN A FEW SECONDS PER DAY IS NOT REQUIRED. GAINS OR LOSSES OF A MINUTE OR MORE A WEEK INDICATE THE NEED FOR REPAIR, NOT REGULATION.

ACCUTRON regulators

The ACCUTRON regulators (see Fig. 4) are serrated to make them easier to rotate and to serve as a calibration.

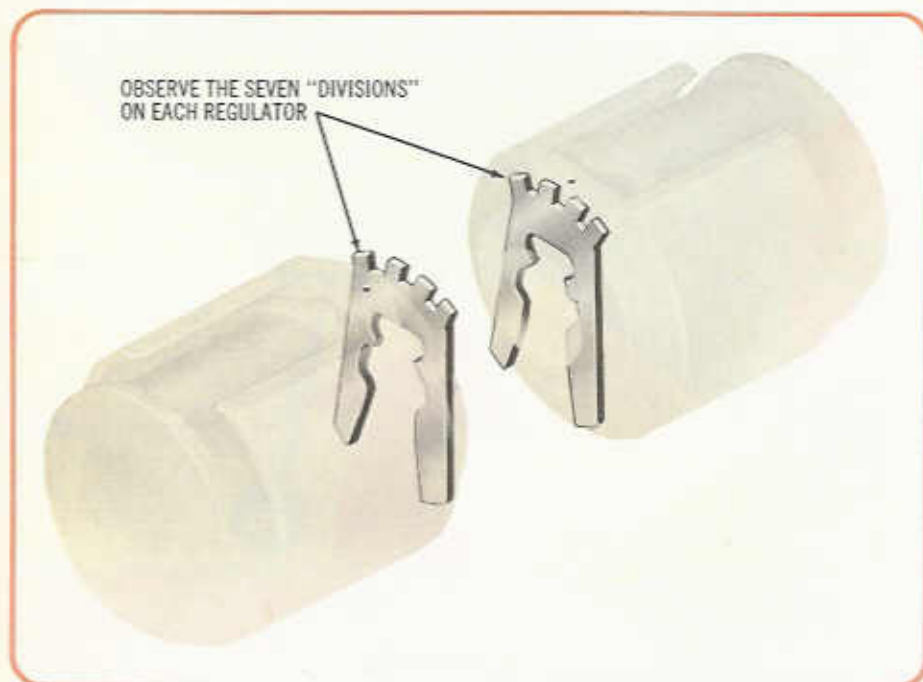

Fig. 4

The serrations of each regulator form 7 divisions (4 projections and 3 indentions). Each of these divisions is equal to 2 seconds per day of correction; in other words, rotating one of the regulators a distance equal to one division, changes the rate of the ACCUTRON timepiece by 2 seconds per day. Regulation for as little as $\frac{1}{2}$ second per day can be made by rotating one of the regulators $\frac{1}{4}$ division. The amount that a regulator is rotated can be easily gaged by reference to the dot on the top of each cup.

Either one or both of the regulators can be rotated in making a correction; for example, a correction of 4 seconds per day can be made either by rotating one regulator 2 divisions, or by rotating each of the regulators 1 division.

Since there are 7 divisions on each of the regulators, and since each division is equal to 2 seconds per day, it would be impossible to make a correction of more than 28 seconds per day, even if both regulators were originally set all the way in one direction.

How To Regulate

Rotate one or both of the regulators (see Fig. 5) a sufficient number of divisions and in the direction necessary to make the required correction. Rotating a regulator away from the center of the movement will cause the ACCUTRON timepiece to run slower; rotating a regulator toward the center of the movement will cause it to run faster.



TO REGULATE 2 SECONDS PER DAY SLOWER,
MOVE EITHER REGULATOR ONE DIVISION
OUTWARD AS SHOWN.



TO REGULATE 2 SECONDS PER DAY FASTER,
MOVE EITHER REGULATOR ONE DIVISION
INWARD AS SHOWN.



Fig. 5



Fig. 6

Removing Movement From Case



- a. Pull stem out (setting position).
- b. Loosen setting lever screw 2 turns. (See Fig. 6.)
- c. Withdraw stem.



Fig. 7



- a. Remove movement from case and place in movement holder.
- b. Insert stem and tighten setting lever screw.

CAUTION: Do not push stem beyond point of engagement with pin on setting lever. (See Special Points, item 2, page 14.)

Replacing Movement In Case

1

- a. Pull stem **out** (setting position).
- b. Loosen setting lever screw 2 turns. (See Fig. 8.)
- c. Withdraw stem.

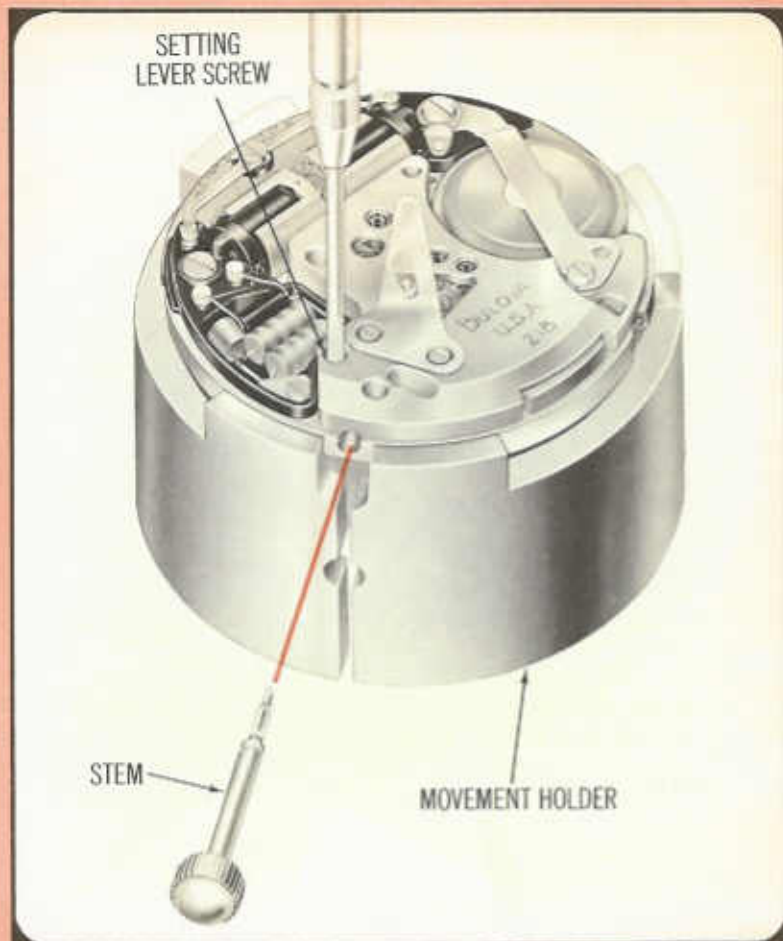

Fig. 8

2

- a. Replace movement in case.
 - b. Lubricate crown gasket with a good quality stem grease.
 - c. Insert stem and tighten setting lever screw.
- Caution:** Do not push stem beyond point of engagement with pin on setting lever. (See Special Points, item 2, page 14.)
- d. Replace gasket and case back. Secure locking ring for water tightness.
 - e. Check regulation. (See step 10, page 39.)



Fig. 9

MAY 24 1965

Part II

Repair of the Basic Movement

Special Tools and Equipment

ACCUTRON service kit

The revised ACCUTRON Service Kit has the special tools necessary to perform diagnosis and to service the 218 ACCUTRON timepiece.

For the 218, the following tools are included:

1. Triple-purpose electric Test Set (Model 600)
2. Movement Holder
3. Locking-ring wrench
4. Collet Adjusting Tool

In addition, the revised ACCUTRON Service Kit has the other special tools necessary to service the 214 movement.

Note: If you already own an ACCUTRON Service Kit for the ACCUTRON Model 214, you can have it modified to handle the ACCUTRON Series 218 as well.

test set

The Model 600 Test Set, illustrated in Fig. 10, is an essential unit in servicing the 218 ACCUTRON movement. The Test Set is required to perform three very important functions:

1. It provides a high resistance voltmeter to check the ACCUTRON Power Cell. (Conventional low-resistance voltmeters are not suitable for this purpose.)
2. It is designed to check the current in the electronic circuit, to indicate its operating condition. (Conventional high-resistance microammeters are not suitable for this purpose.)
3. It provides an accurate source for the reduced voltages required for the adjustment of the 214 and the 218 indexing mechanisms. (The two voltages are not the same.)

Note: The Model 600 Test Set is designed for use with both the 218 and the 214 ACCUTRON movements.

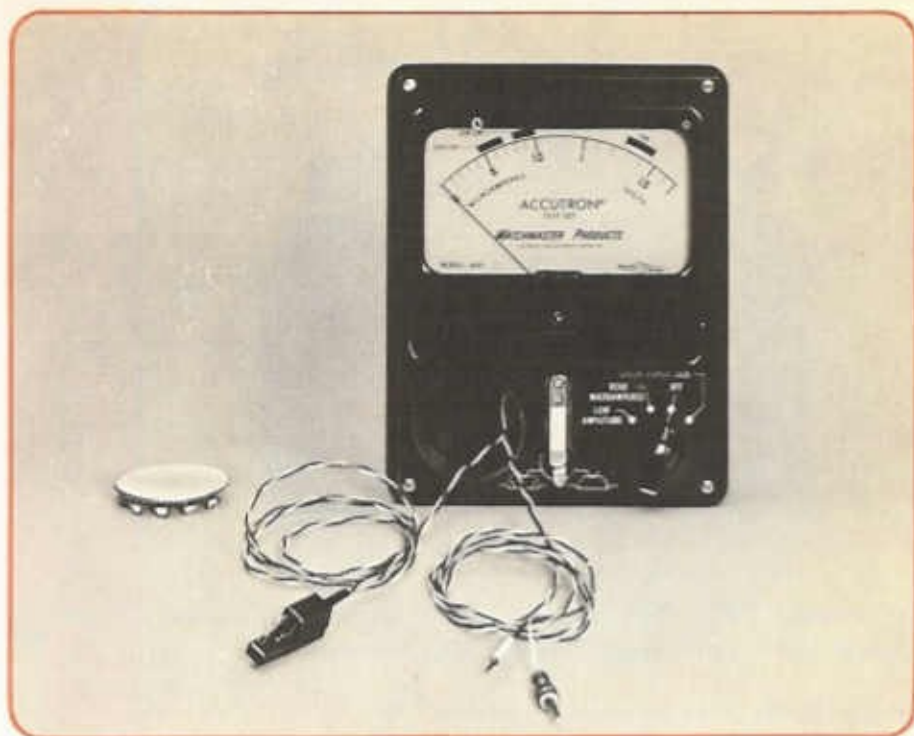

Fig. 10
Model 600 Test Set

The Test Set provides:

1. A "nest" to hold a Power Cell during testing. The nest is clearly marked for proper insertion of either the 214 Power Cell or the 218 Power Cell.
2. A meter, reading either volts or microamperes, indicating the correct values by areas marked "OK."
3. A 4-position Rotary Switch for the selection of the various test conditions:
 - Position 1—"CHECK POWER CELL"
 - Position 2—"OFF"
 - Position 3—"READ MICROAMPERES"
 - Position 4—"LOW AMPLITUDE". In this position the Test Set supplies the appropriate reduced voltage for important Indexing Mechanism Adjustment, for both the 214 and 218 movements.
4. A 2-wire lead, with a tab end and a plug end for attachment to the 218 ACCUTRON movement and movement holder.
5. A 2-wire lead, with a spring clip for attachment to the 214 ACCUTRON movement.
6. A black screw, directly below the center of the movement dial, for zeroing the meter hand.



Fig. 11

movement holder

The Movement Holder (Fig. 11) is specially designed for the 218 ACCUTRON movement and is used to hold the movement whenever it is removed from the case. The electrical jack on the Movement Holder is used to accommodate the plug tip end of the 2-wire lead from the Test Set.

locking-ring wrench

A wrench, designed for opening the case, is illustrated in Fig. 12.

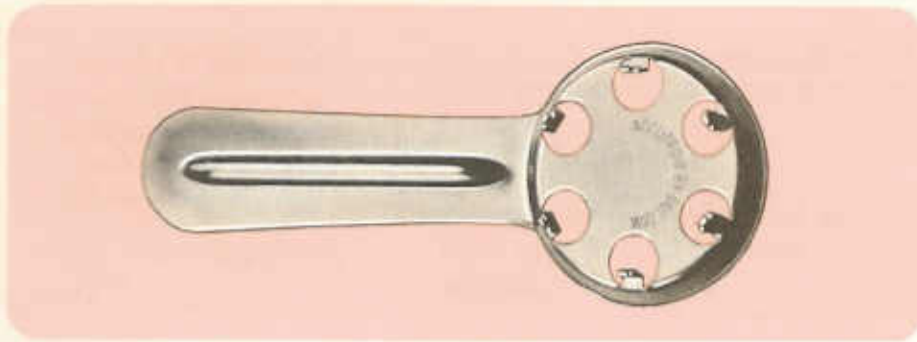

Fig. 12

collet adjusting tool

This tool, illustrated in Fig. 13, is used to adjust the engagement of the index and pawl fingers. It is inserted in the index finger collet or the pawl finger collet and gently turned to position the index or pawl jewel with respect to the index wheel.



Fig. 13

cleaning equipment

Ultrasonic equipment is strongly recommended for cleaning the mechanical section of the ACCUTRON movement. The infinitesimal size of the 320 teeth on the beryllium-copper index wheel requires the maximum penetration power available in ultrasonic cavitation generated by nickel transducers. The WATCHMASTER ultrasonic Watch Cleaner is recommended.

rate recorder

The rate of the ACCUTRON tuning fork can be recorded only on equipment specifically designed for that purpose. A special transistorized amplifier, with suitable frequency dividers, has been developed by Bulova engineers to show this rate. This ACCUTRON Rate Recorder will also record popular odd beat, spring driven and electric watches.

Note: For further information on the ACCUTRON Service Kit, the ACCUTRON Power Cell Tester*, the WATCHMASTER Ultrasonic Cleaner or the ACCUTRON Rate Recorder, write to:

Technical Sales & Services Division
 Bulova Watch Company, Inc.
 Bulova Park
 Flushing, N. Y. 11370

*Not shown in this publication.

SYMPTOM	POSSIBLE CAUSES (in order of probability)	DIAGNOSTIC PROCEDURE	CORRECTIVE ACTION REQUIRED
GAINING OR LOSING A FEW SECONDS PER DAY	Abnormal condition of use or improper regulation.	No diagnosis required.	Regulate (page 5).
IRREGULAR DAY-TO-DAY RATE (gains a few seconds per day, loses a few seconds the next, etc.)	Inaccurate source of time for checking Accutron rate.	Determine source of time used for checking performance.	Recommend (a) checking performance over 1 month period in keeping with guarantee, or (b) use of accurate time source for daily checking.
GAINING OR LOSING EXCESSIVELY (minutes per week)	<ol style="list-style-type: none"> 1. Hands rub or catch slightly. 2. Poor contact between cell strap & Power Cell. 3. Indexing mechanism out of adjustment. 4. Mechanical interference with free vibrations of fork. 5. Train partially blocked. 6. Damaged teeth on index wheel. 	<p>Check crystal clearance. Inspect for adequate clearance between hands and between hands and dial markers.</p> <p>Inspect Power Cell and cell strap for an adherent deposit of dried electrolyte which may sometimes "push" the cell strap away from the Power Cell.</p> <p>Check adjustment of indexing mechanism (pages 15-18).</p> <p>Check movement current (page 19). If current is above OK range, rotate index finger collet to disengage jewel from index wheel. If current remains above OK range, fork may be blocked.</p> <p>If movement current was above normal in step 4 (above) but current is OK with index mechanism disengaged, train is partially blocked. Check train freedom (page 20).</p> <p>See "Special Points" (page 14), item 3</p>	<p>Adjust hand clearance. Be sure to pull out crown during adjustment to avoid damaging indexing mechanism.</p> <p>Clean and replace Power Cell and cell strap, as described on page 4 ("d" & "e").</p> <p>Adjust indexing mechanism, if necessary (pages 15-18).</p> <p>Remove blockage. Readjust indexing mechanism (pages 15-18).</p> <p>Remove blockage. Readjust indexing mechanism (pages 15-18).</p> <p>Replace index wheel (disassembly procedures 1-4, pages 21-24, and reassembly procedures 6-8, pages 37-39). Check adjustment of indexing mechanism (pages 15-18).</p>
STOPPED no hum	<ol style="list-style-type: none"> 1. Exhausted Power Cell. 2. Open drive coil. 3. Mechanical blockage of tuning fork. 4. Faulty electronic circuit. 	<p>Open case, remove Power Cell and check its voltage (page 19). If voltage is low, Power Cell is exhausted.</p> <p>Check movement current (page 19). If no current, one of the drive coils is "open."</p> <p>If movement current is above OK range in step 2 (above), rotate index finger collet to disengage jewel from index wheel. If current remains above OK range, fork may be blocked.</p> <p>If movement current is high and tuning fork is not blocked, electronic circuit is faulty.</p>	<p>Replace Power Cell (page 4).</p> <p>Identify defective coil (page 20) and remove same (disassembly procedures 1-5, pages 21-25, and reassembly procedures 5-8, pages 36-39). Readjust indexing mechanism (pages 15-18).</p> <p>Remove blockage. Readjust indexing mechanism (pages 15-18).</p> <p>Replace component coil assembly (disassembly procedures 1-5, pages 21-25) and reassembly procedures 5-8, pages 36-39). Readjust indexing mechanism (pages 15-18).</p>

STOPPED
Sweep
second
hand does
not turn
but fork
hums.

1. Crown in setting
("out") position.

Check to see if crown is pressed in.

Press crown "in."

2. Power Cell voltage
low.

If crown is "in," open case, remove Power Cell and check its voltage (page 19). If voltage is low, Power Cell is exhausted.

Replace Power Cell (page 4).

3. Hack mechanism
out of adjustment.

Remove movement from case and place in movement holder (page 7). Check adjustment of hack mechanism (page 20).

Adjust hack mechanism
(page 20).

4. Indexing
mechanism out
of adjustment.

Check adjustment of indexing mechanism (pages 15-18).

Adjust indexing mechanism
(pages 15-18).

5. Mechanical inter-
ference with free,
vibrations of fork.

Check movement current (page 19). If current is above OK range rotate index finger collet to disengage jewel from index wheel. If current remains above OK range fork may be blocked.

Remove blockage. Readjust
indexing mechanism (pages 15-18).

6. Mechanical
blockage
of train.

If movement current was above normal in step 5 (above) but current is OK with index mechanism disengaged, train is partially blocked. Check train freedom (page 20).

Remove blockage. Readjust
indexing mechanism (pages 15-18).

7. Dirt in tooth of
index wheel.

If above checks prove negative, connect test set with switch in "read microamperes" position. With crown "in," tap movement holder at 3 or 9 o'clock position with finger to increase fork amplitude, while observing closely with loupe. If index wheel rotates once, then stops again, there may be dirt in index wheel teeth.

Remove index wheel
(disassembly procedures 1-4,
pages 21-24). Clean wheel and
reassemble. Readjust indexing
mechanism (pages 15-18).

8. Damaged teeth on
index wheel.

If test in step 7 (above) is positive but is not corrected by cleaning index wheel, index wheel teeth have been damaged. See "Special Points" (page 14), item 3.

Replace index wheel
(disassembly procedures 1-4,
pages 21-24, and reassembly
procedures 6-8, pages 37-39).
Readjust indexing mechanism
(pages 15-18).

STOPPED
Hour and
minute
hands
stopped but
sweep
second
hand turns.

1. Hands catch.

Inspect for adequate clearance between hands and between hands and dial markers.

Adjust hand clearance. Be sure
to pull out crown during
adjustment to avoid damaging
indexing mechanism.

2. Stoppage in dial
train.

If hand clearances are satisfactory, remove dial and hands (page 21). Inspect for foreign matter or other stoppage interfering with free turning of dial train.

Remove blockage.

Special Points for the ACCUTRON Repairman

The ACCUTRON movement, being completely different from conventional watch movements, requires different techniques in its repair. Otherwise, it may be damaged by improper procedures on the part of the repairman. For example, turning the hands or the gear train (in either direction) with the hack lever disengaged, will damage the index wheel teeth or the index and pawl fingers. The repairman's attention is called to the following special points:

1. **Removing or Replacing Hands** Always pull crown **out** (setting position) before touching the hands for any reason.
2. **Replacing Stem** As with conventional watches, the stem should preferably be pulled "out" (setting position) before loosening the setting lever screw to remove the stem. In replacing the stem, if it is pushed in, beyond the point of engagement with the pin on the setting lever, the hack lever may be depressed. In this instance, turning the crown will damage the indexing mechanism. For this reason, **do not push the stem in beyond the point where the stem groove may be engaged by the setting lever pin, before tightening the setting lever screw.**
3. **Index Wheel** The teeth on the index wheel will not wear away in normal use, nor can they be damaged as a result of any accident, when the movement is enclosed in its case (with the crystal intact). **The index wheel can only be damaged by improper handling on the part of the repairman.** If it is suspected that the teeth on the index wheel have been damaged, the most practical solution is to replace it, since visual examination will rarely disclose the damage—because of the size of these tiny teeth.
4. **Electrical Contact** Make a habit of cleaning the cell strap, which can be done efficiently with an eraser, and wiping any white adherent material, if present, from the Power Cell. Such material may (sometimes) "push" the cell strap away from the Power Cell and thereby break electrical contact. In such instances removing the residue, particularly on the underside of the cell strap will prevent a latent problem in this regard.
5. **Circuit** **The use of electrical test equipment or procedures other than those recommended, should be avoided.** In particular, circuit elements can be damaged by the use of an ohmmeter for testing the circuit.
6. **Magnetism** Never demagnetize an ACCUTRON movement or expose it to high-strength magnetic fields (permanent magnets, for example).
7. **Magnets Partially Demagnetized** Diagnosis procedures in the preceding servicing instructions have not covered the identification of trouble caused by demagnetized tuning fork magnets, for reasons of simplification. Experience has shown that such trouble is very rare. If the movement current is within the "OK" area of the scale on the Test Set, the magnets are satisfactorily magnetized.
If the tuning fork magnets have lost most of their magnetism, the tuning fork will fail to vibrate and the Test Set will indicate a very high current—normally interpreted as due to a faulty electronic circuit. If the magnets have lost only a portion of their magnetism, the tuning fork may vibrate but the Test Set will indicate that the current is above the "OK" area of the scale. In each of these instances, if an excessively high current (and/or failure of the tuning fork to vibrate) cannot be corrected by replacing the complete coil assembly—try substituting a different tuning fork.
If the tuning fork magnets have been demagnetized—the tuning fork assembly must be returned to Bulova for remagnetizing.
8. **Adjustment of Indexing Mechanism** It is always good practice to check the adjustment of the indexing mechanism *after* replacing the dial and hands. This is because the adjustment of the indexing mechanism can change as a result of the slightest turning of the center second pinion when the hand is applied.

MAY 24 1969

Indexing Mechanism—Inspection and Adjustment

The checking and adjustment of the ACCUTRON indexing mechanism is extremely important to its operation. This is accomplished by closely controlling the alignment and the depth of engagement of the index and pawl jewels and their interrelation. Details of the step by step procedure necessary to properly accomplish these adjustments are to be performed in sequence, as follows:

Note: Perform hack mechanism inspection and adjustment (page 20) before the following steps.

1. Check that stem is in (running position). Remove casing spring (2 screws) and power cell (Fig. 14).

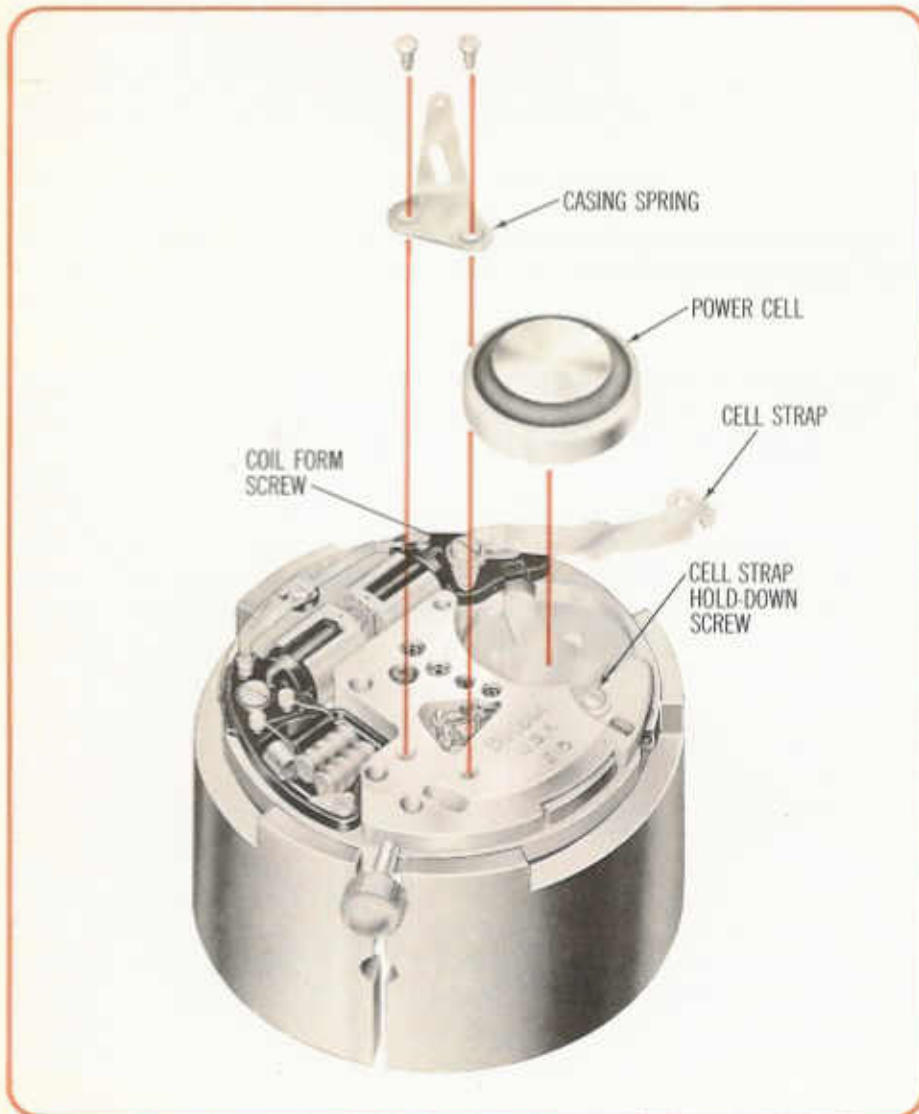

Fig. 14

2. The lower surfaces of the index and pawl jewels must be parallel to their respective fingers, as shown in Fig. 15. Correction of this alignment is rarely required. It can usually be accomplished, if necessary, without breaking the cement attaching the jewel to the finger by exercising watchmaking care. Grasp the finger with tweezers, close to the jewel, and press lightly on the end of the jewel or finger in the proper direction with pegwood, to correct the alignment of jewel and finger.

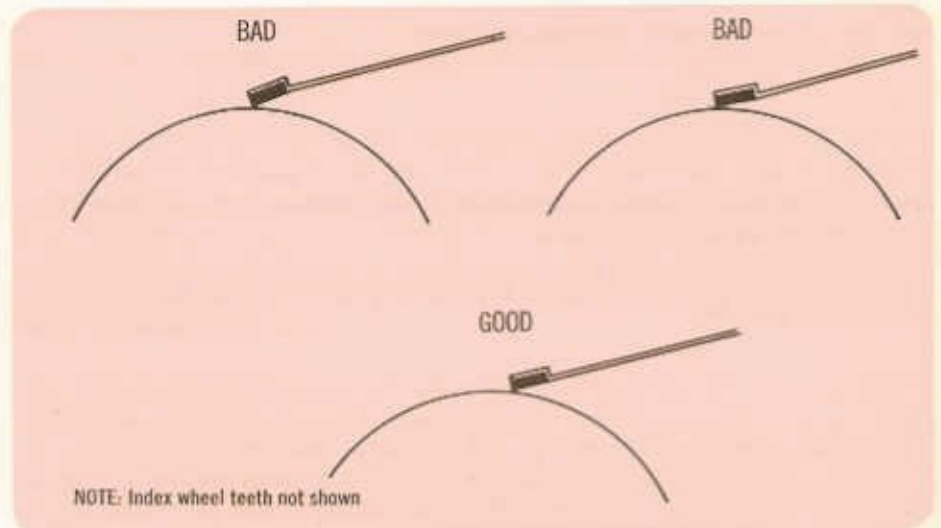

Fig. 15

For the proper operation, the two fingers must be straight. Obviously, when the fingers are unstressed (disengaged from wheel), there will be a slight curve.

Both of the jewels must be perpendicular to the wheel. Either jewel can be made perpendicular to the plane of the index wheel by grasping the jewel finger close to its pinning point and twisting slightly. (See Fig. 16.) Centering the index and/or pawl jewel is accomplished by alignment of the respective post. Gently stress the index or pawl post by grasping or pushing the end of the post with tweezers or a suitable screwdriver. (See Fig. 17.) This very slight bending of the post will raise or lower the index or pawl jewel in relation to the index wheel. Exercise normal watchmaking care in readjusting the various parts of the ACCUTRON indexing mechanism.

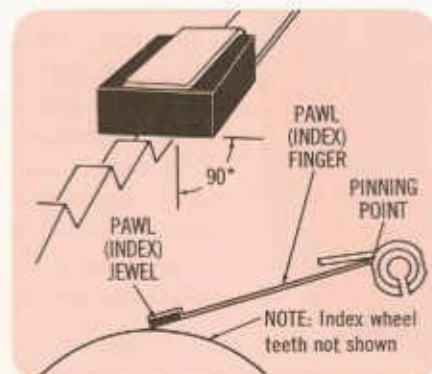

Fig. 16

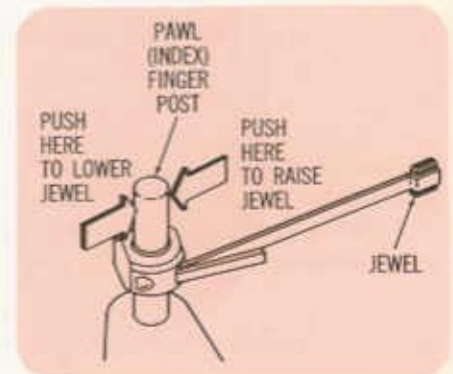

Fig. 17

3. Rotate index finger collet until index jewel completely disengages from index wheel. Observe gap between index gage and index finger. (See Fig. 18.) The gage must not touch the finger, but should preferably be very close, say within one index finger thickness. This, as you will see, will make it easier to perform step 4. If gap does not meet requirements, bend index gage at its attached end until the proper gap is obtained.

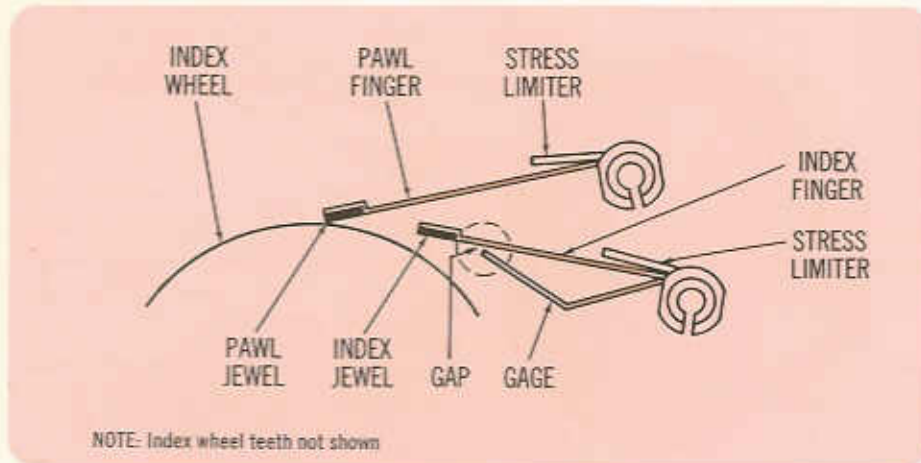

Fig. 18

4. Use collet adjusting tool to rotate index collet, bring index jewel into wheel until the gap is larger than it was in step 3 by 1 to $1\frac{1}{2}$ index jewel thicknesses. If the gap in step 3 was less than the thickness of the index finger, for practical purposes this gap should be increased to about $1\frac{1}{2}$ jewel thicknesses at the completion of collet adjustment. (See Fig. 19.)

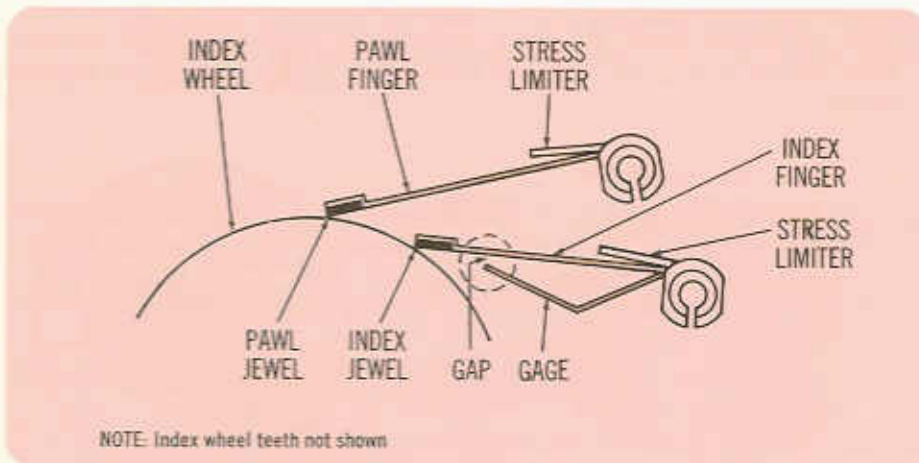

Fig. 19

5. Observe the stress limiters on index and pawl fingers. (See Fig. 19.) Check that no more than $\frac{1}{3}$ of the length of the stress limiter is in contact with the index or pawl finger. Also, check that end of stress limiter is no more than 3 thicknesses of the stress limiter away from index or pawl finger. If adjustment is necessary, use tweezers to bend stress limiter; then repeat steps 3 and 4.
6. Loosen pawl bridge lock screw slightly; leave pawl bridge pivot screw tight.

7. Rotate pawl bridge cam until pawl bridge is in its maximum clockwise position (maximum position in the direction to disengage pawl jewel from index wheel). The pawl jewel should not be touching the index wheel, and not more than one-half its thickness away from the wheel. This distance may be adjusted using the collet adjusting tool.

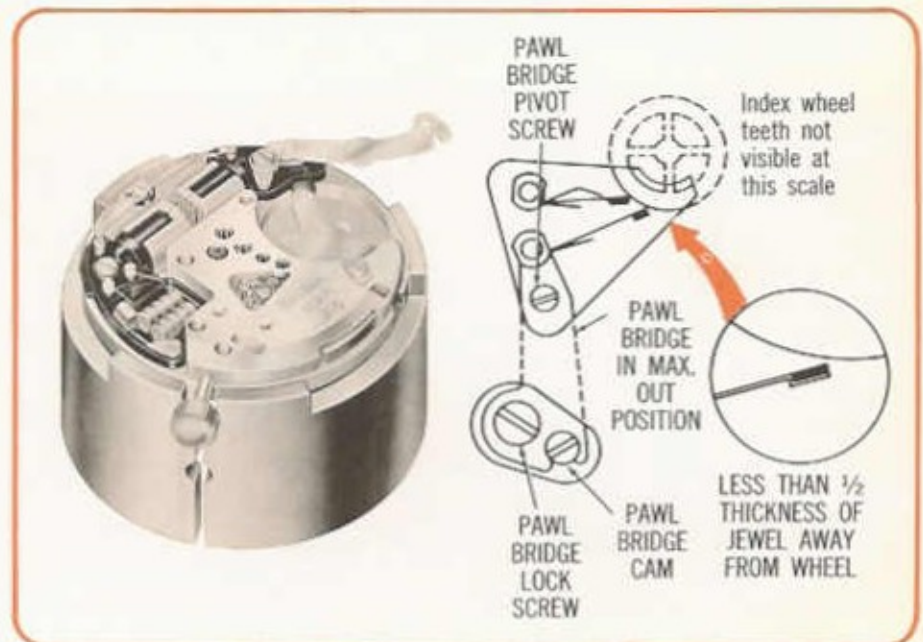

Fig. 20

8. Insert plug tip of Test Set lead into the jack of the movement holder. Insert tab tip of other lead of Test Set under strap as shown in Fig. 21. With PowerCell in the nest of Test Set, turn rotary switch to "LOW AMPLITUDE" position. If tuning fork does not begin to vibrate, an excess current reading will be indicated on meter of Test Set. Should this occur, tap movement holder lightly and fork will start. Current reading will then drop to the lower end of "OK" area, or slightly below.

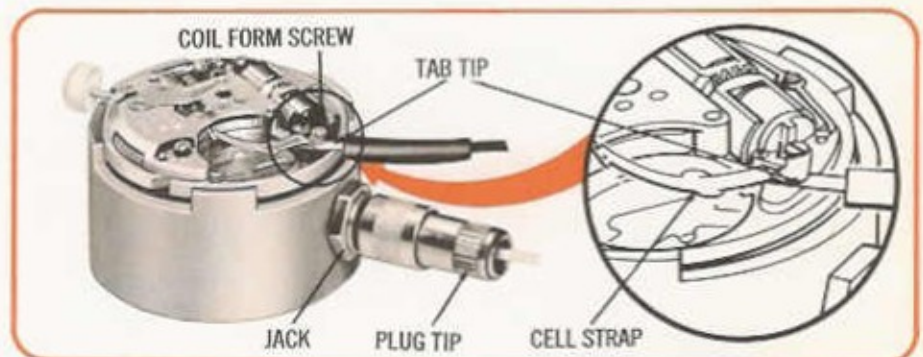

Fig. 21

9. Rotate the pawl bridge cam **VERY SLOWLY** in either direction (since it was at its maximum distance away, rotating either clockwise or counterclockwise will move the pawl jewel toward the wheel) until movement begins to run. This can be seen merely by watching the wheels that are visible. **TURN THE CAM FARTHER IN THE SAME DIRECTION UNTIL THE TRAIN STOPS, AND THEN CONTINUE STILL FARTHER UNTIL YOU REACH THE POINT WHERE IT STARTS AGAIN AND CONTINUES TO RUN (Momentary hesitation permissible)**

10. Tighten the pawl bridge lock screw and check the tightness of the pawl bridge pivot screw, to assure that the bridge is rigidly clamped in position. The ACCUTRON train should continue to run (Test Set switch at "LOW AMPLITUDE" position). If it does not, the adjustment must be made again (steps 7 through 10).

11. Disconnect the Test Set from the movement.

Testing 218 Power Cell



1. Place the Power Cell (with yellow seal up) in nest of Test Set.
2. Turn rotary switch on Test Set to "CHECK POWER CELL" position.
3. Read Power Cell voltage on right-hand scale. The voltage reading should be in the "OK" area of scale (1.25 to 1.45 volts). If it is, Power Cell is in satisfactory operating condition.

Note: Poor electrical contact between Power Cell and Test Set will cause either a low reading or a wavering indication of cell voltage. It can be readily avoided by making certain that Power Cell surfaces and contacting points of the Test Set nest and clip are clean. Rubbing or twisting a suspected cell between the contacts while checking voltage is good practice. A wavering reading of voltage is always an indication of poor contact, not an indication of a bad cell. Testing should always be done with the authorized ACCUTRON Test Set or with a high-resistance voltmeter (having not less than 10,000 ohms per volt sensitivity), such as the ACCUTRON Power Cell Tester*.

Caution: Never use substitute cells in place of the genuine "ACCUTRON 218" Power Cell. Though other cells may look the same, they will not reliably operate this model timepiece and may, in some instances, seriously damage the movement. The only correct Power Cell has "ACCUTRON 218" imprint (see picture above).

Testing Electronic Circuit

The following procedure is performed with the Power Cell in the nest of the Test Set and the movement positioned in the movement holder.

1. Insert plug tip of Test Set lead into the jack of the movement holder. (See Fig. 21.)
2. Insert tab tip of other lead of Test Set under cell strap as shown in Fig. 21.
3. Turn rotary switch on Test Set to "READ MICROAMPERES" position. The Test Set meter should give a reading of current on left-hand scale. (It may be necessary to tap movement lightly to start tuning fork vibrating after connecting Test Set leads.)
4. Observe current reading. If reading is in the "OK" area of scale (8.0 to 10.0 microamperes for the dialed movement with indexing mechanism engaged) electronic circuit is operating satisfactorily. Bare fork operation (that is pillar plate, tuning fork and coils only) may give a current reading as low as 6 microamperes.

*Not shown in this publication

Identifying Defective Coil Assembly

This procedure is intended to identify which coil assembly is defective, when a check of the movement current results in a zero current reading, indicating improper functioning of the electronic circuit.



Note: Mechanical interference, caused by improper adjustment and/or any factor (such as lint) which restricts or work-loads the fork may result in abnormal Test Set readings. Unless the circuit is "open" (current reads zero), it is rarely necessary to replace the coil assembly during repair of ACCUTRON. If the tuning fork vibrates, an ACCUTRON problem is not due to a faulty coil assembly. Higher than normal current or variable current are (with very rare exception) always caused by other factors.

Assuming the Power Cell has been checked and the Test Set properly connected to the movement, yet the meter indicates zero current, perform the following simple test:

Remove the plug-tip lead from the jack in the movement holder and touch it to the lead strap screw between the two coil assemblies. The defective (open) coil may be identified by whether the current indicated by the meter:

- a. Remains zero—Replace the cell coil assembly
- b. Becomes excessive—Replace the component coil assembly

Checking the Train for Freedom

This check is used to determine whether there is any mechanical blockage of the gear train.

The most sensitive and convenient method of checking the train freedom is to pluck, or "twang" the tine of the tuning fork to which the index finger is attached. When this is done, the fork will vibrate for a few seconds and this motion will be transmitted to the train—if it is not blocked.

The motion of the train can easily be seen by watching any of the wheels at the time that the fork is being plucked. If no motion of the gears is apparent when the fork is plucked, this is evidence of a blocked train, assuming that the indexing linkage has already been checked.

The freedom of the train may also be checked by simply moving one of the wheels with a tweezers or needle with both pawl and index collets rotated to disengage the respective jewels from the index wheel.

Hack Mechanism—Inspection and Adjustment

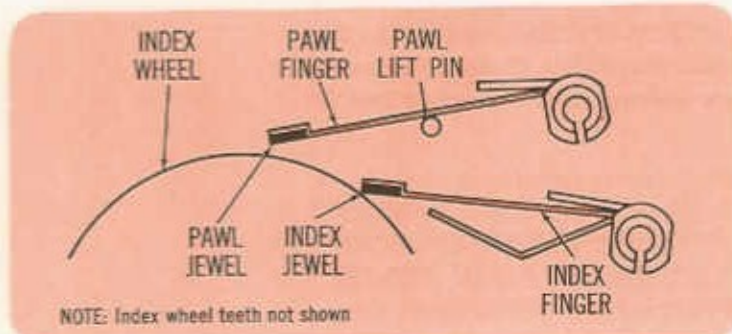

1. Pull stem out (setting position).

2. Pawl jewel should be from $\frac{1}{2}$ to 1 jewel thickness away from index wheel. (See Fig. 22.) If necessary adjust by bending pawl lift pin

Fig. 22

MAY 24 1968
MAY 24 1968

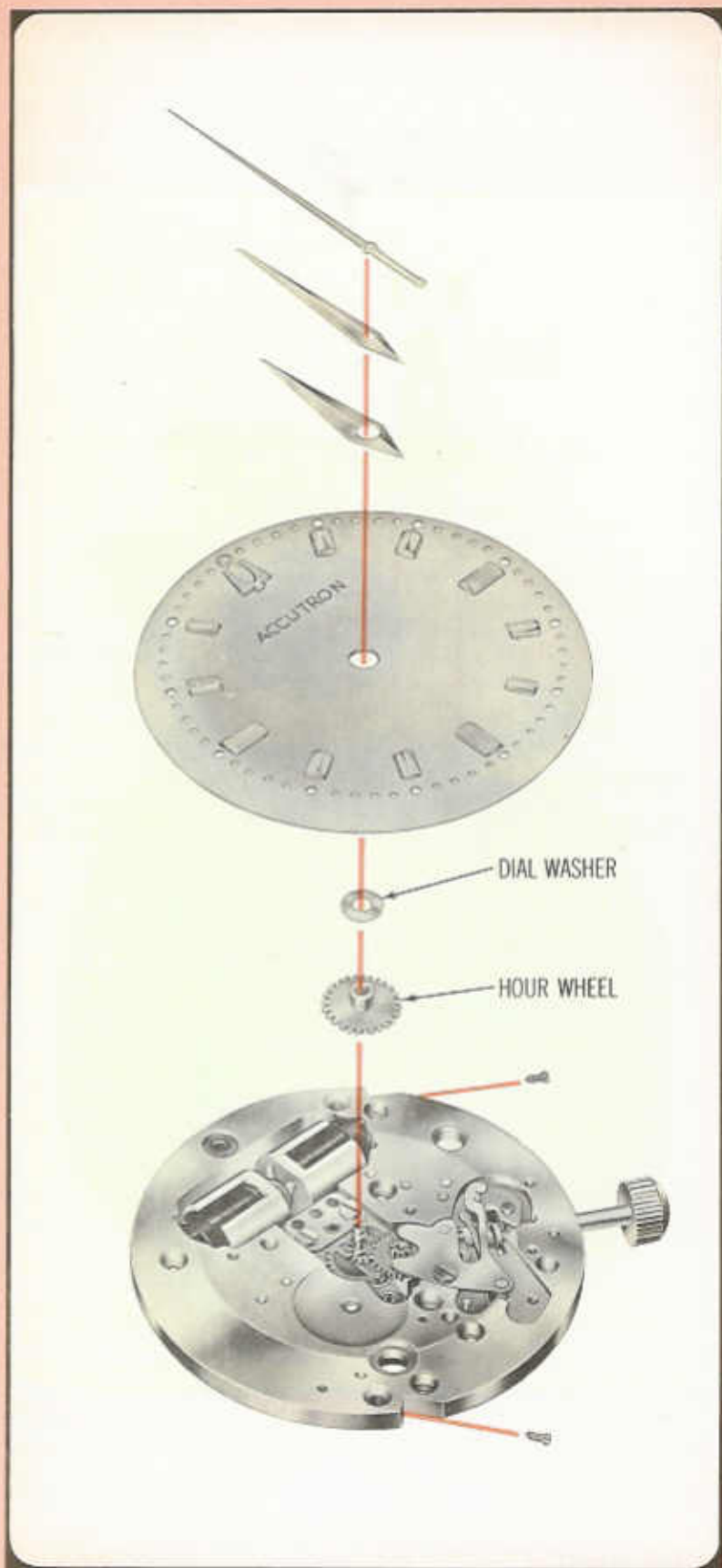

1

Removing hands, dial, and hour wheel

- a. Pull stem out (setting position).
- b. Remove hands.
- c. Remove dial (2 screws).
- d. Remove hour wheel with dial washer.

Fig. 23

MAY 24 1969

2

Removing power cell and casing spring

- a. Loosen cell strap hold down screw and coil form screw.
- b. Turn cell strap counterclockwise and remove power cell.
- c. Remove casing spring (2 screws).

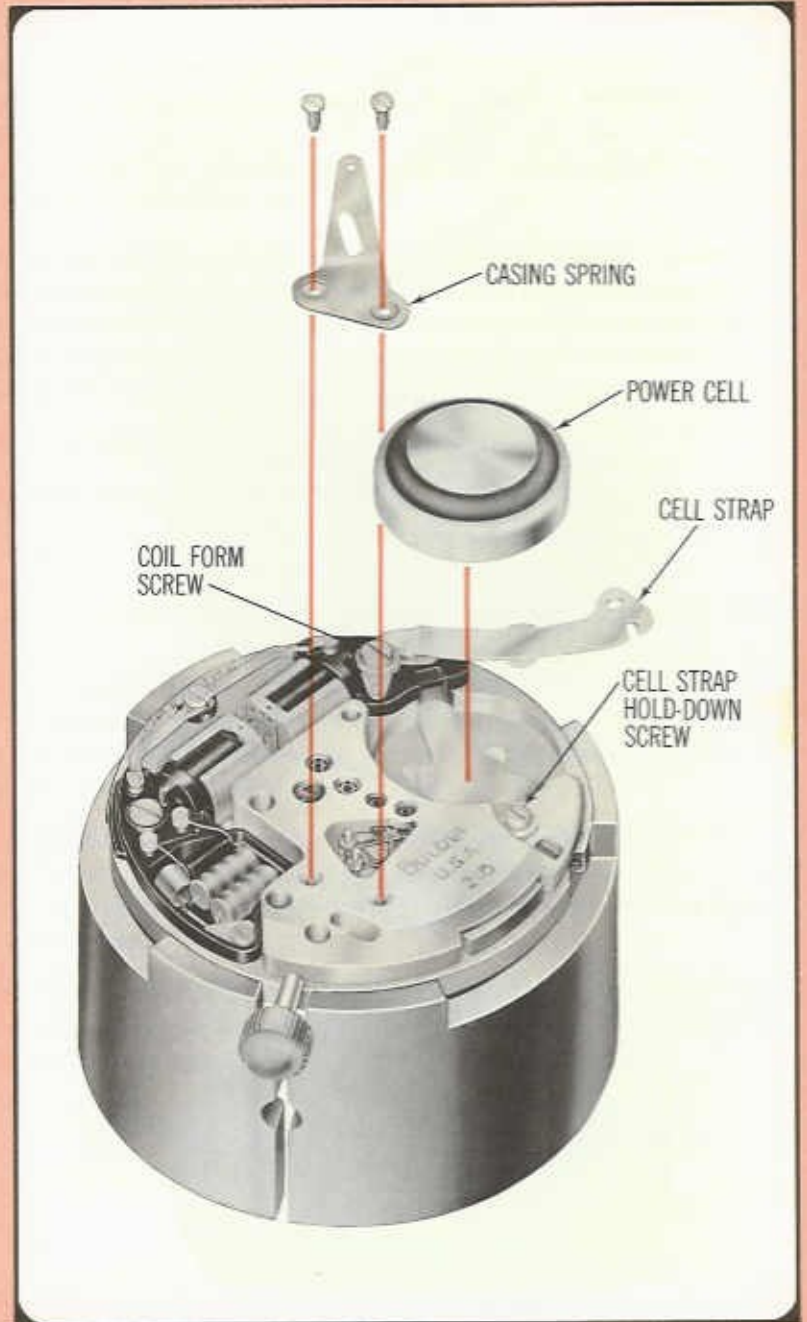

Fig. 24



Disengaging index and pawl fingers

- a. Push stem in (running position).
- b. Use collet adjusting tool to rotate index and pawl fingers away from index wheel.

Fig. 25

4

Removing train bridge and train wheels

- a. Remove train bridge (4 screws).
- b. Remove train wheels.

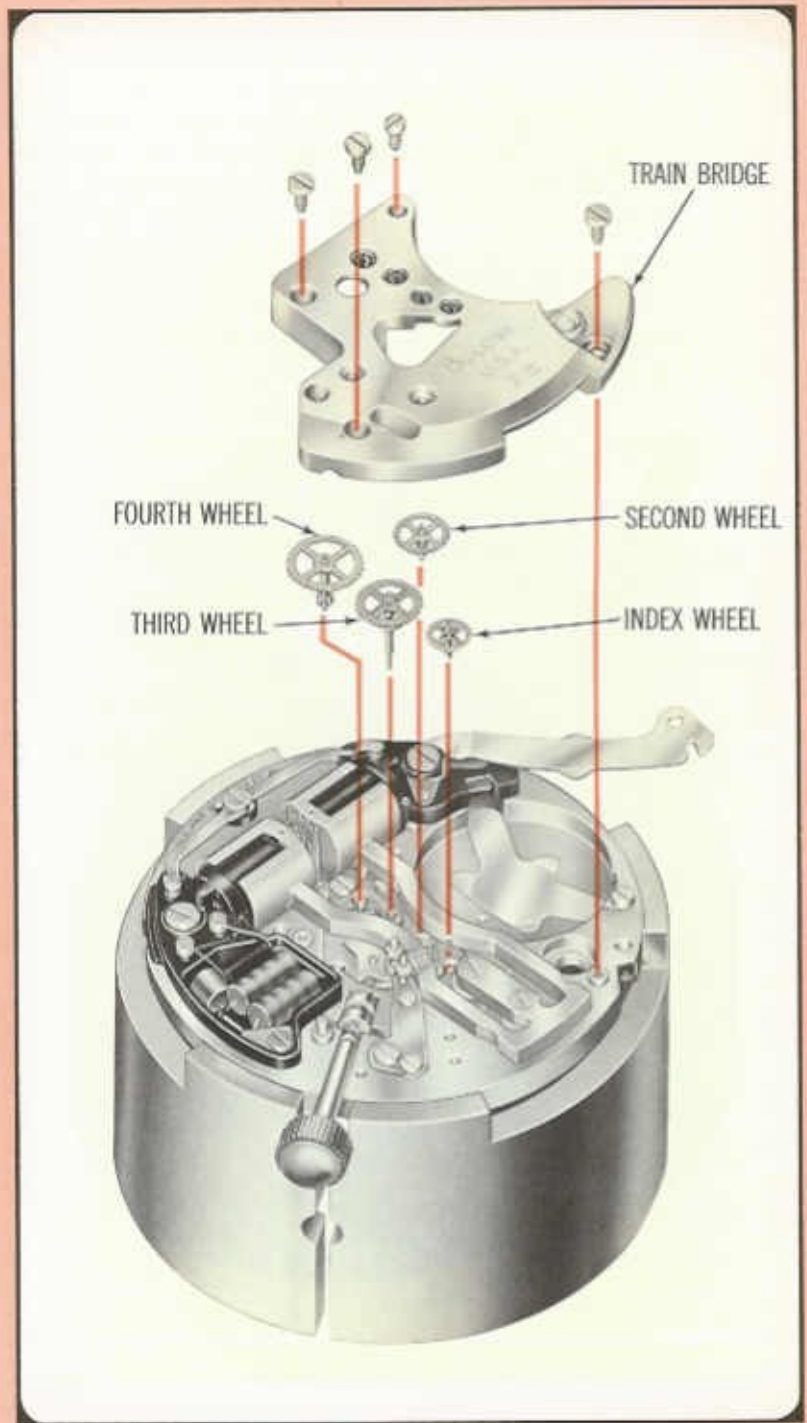
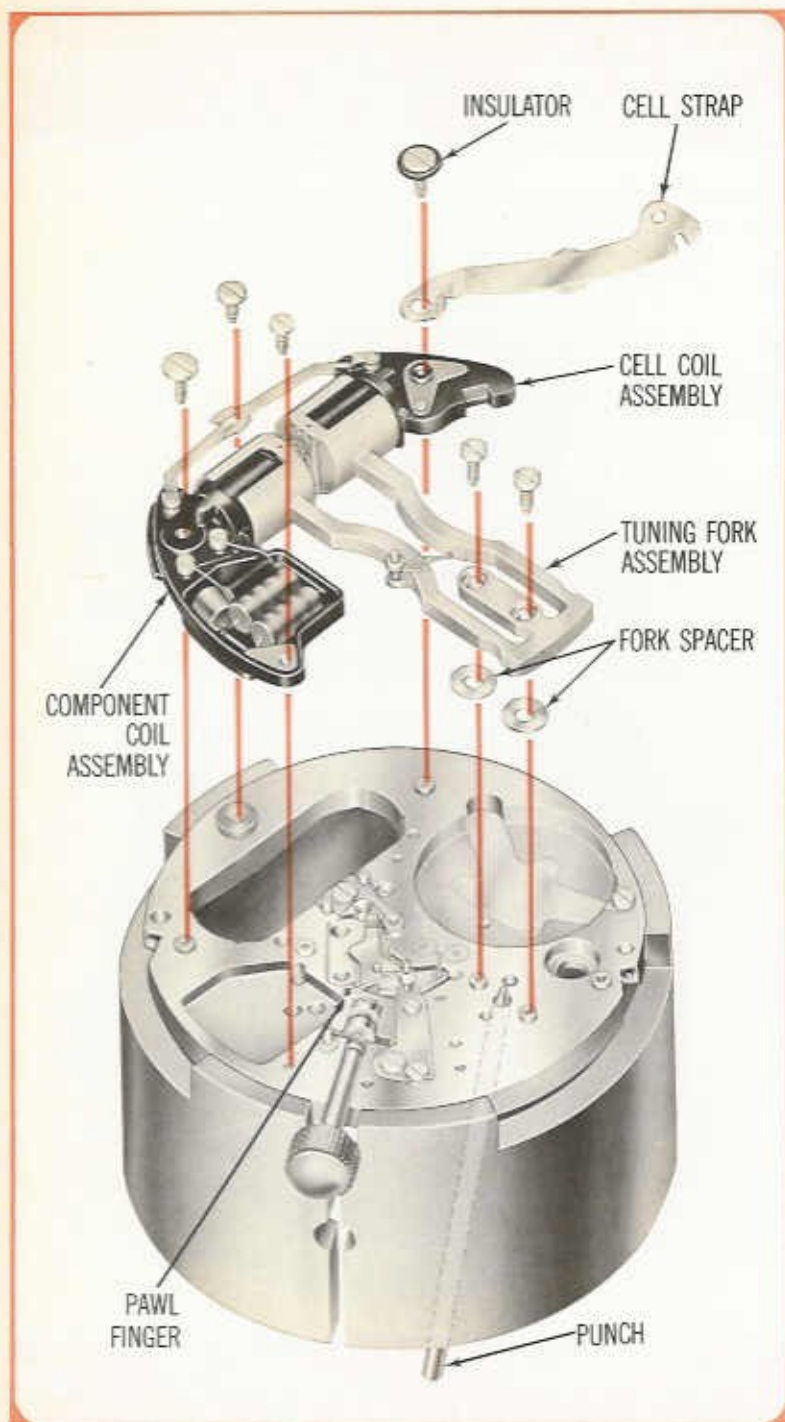

Fig. 26

MAY 24 1969



Removing tuning fork and coil assemblies

a. Rotate pawl finger assembly clockwise 180 degrees to clear tuning fork and pawl bridge pivot screw.

b. Remove tuning fork and coil assemblies (6 screws).

CAUTION: Do not pry at base of tuning fork. Use a punch to push tongue of tuning fork through push-off hole on dial side.

c. Note position of fork spacers. Colors denote different thicknesses.

Fig. 27

MAY 24 1969

6

Removing pawl bridge and hack lever

- a. Remove pawl bridge and cam
(2 screws).
- b. Remove hack lever and
hack lever spring.

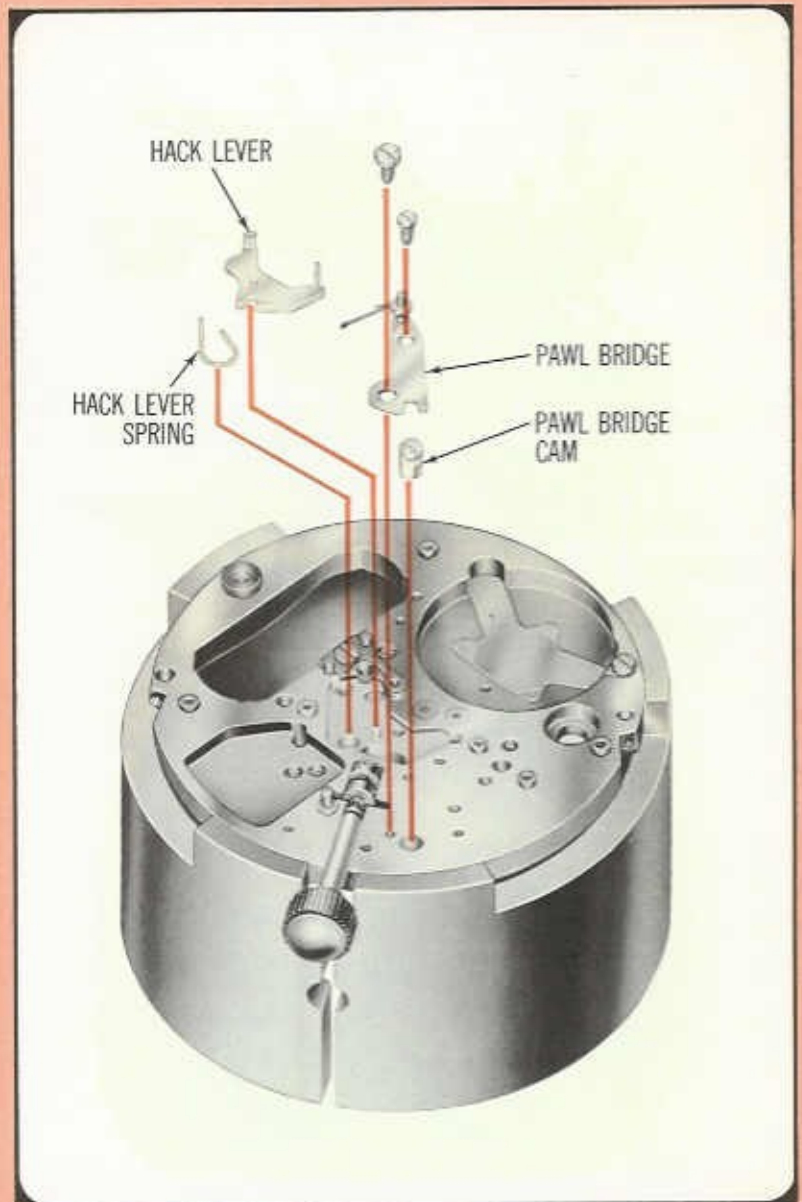
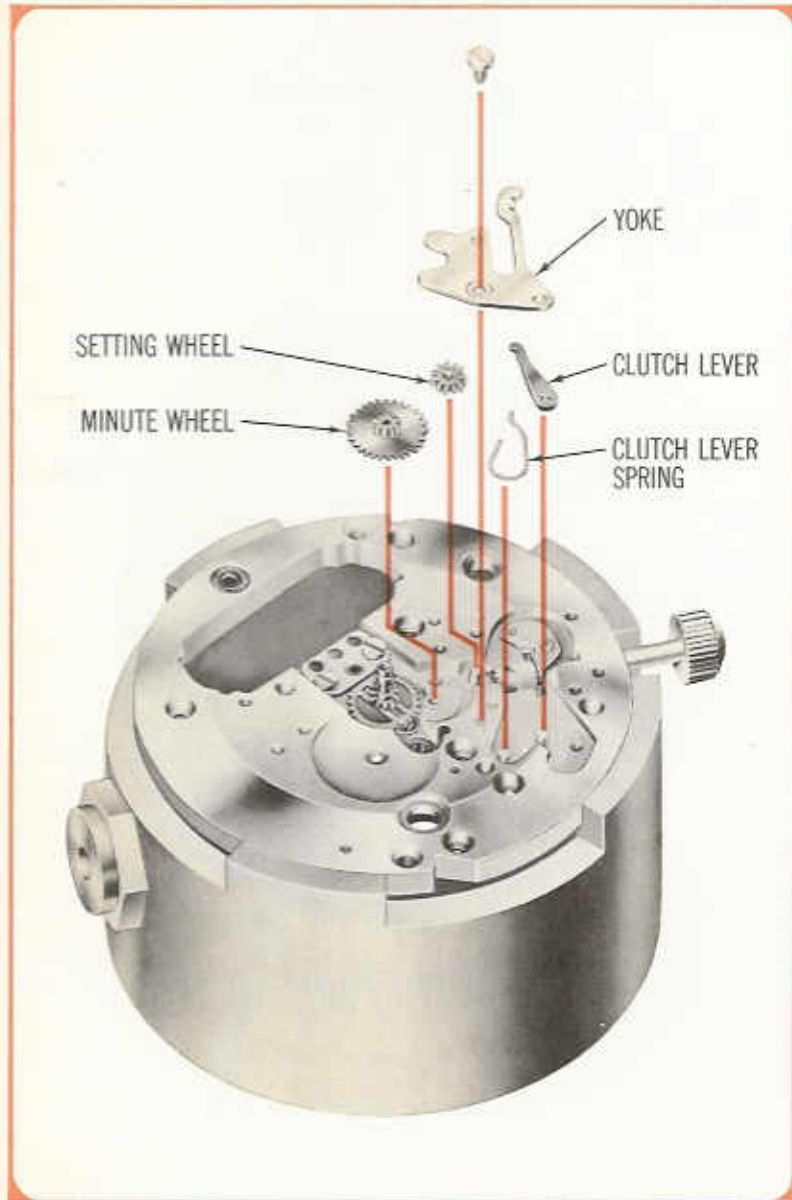

Fig. 28



Removing yoke, clutch lever, and setting and minute wheels

- a. Remove yoke (1 screw).
- b. Remove clutch lever spring and clutch lever.
- c. Remove setting wheel and minute wheel.

Fig. 29

MAY 24 1969

8

Removing fourth bridge and center wheel assembly

- a. Remove fourth bridge (2 screws).
- b. Remove center wheel assembly.



Fig. 30

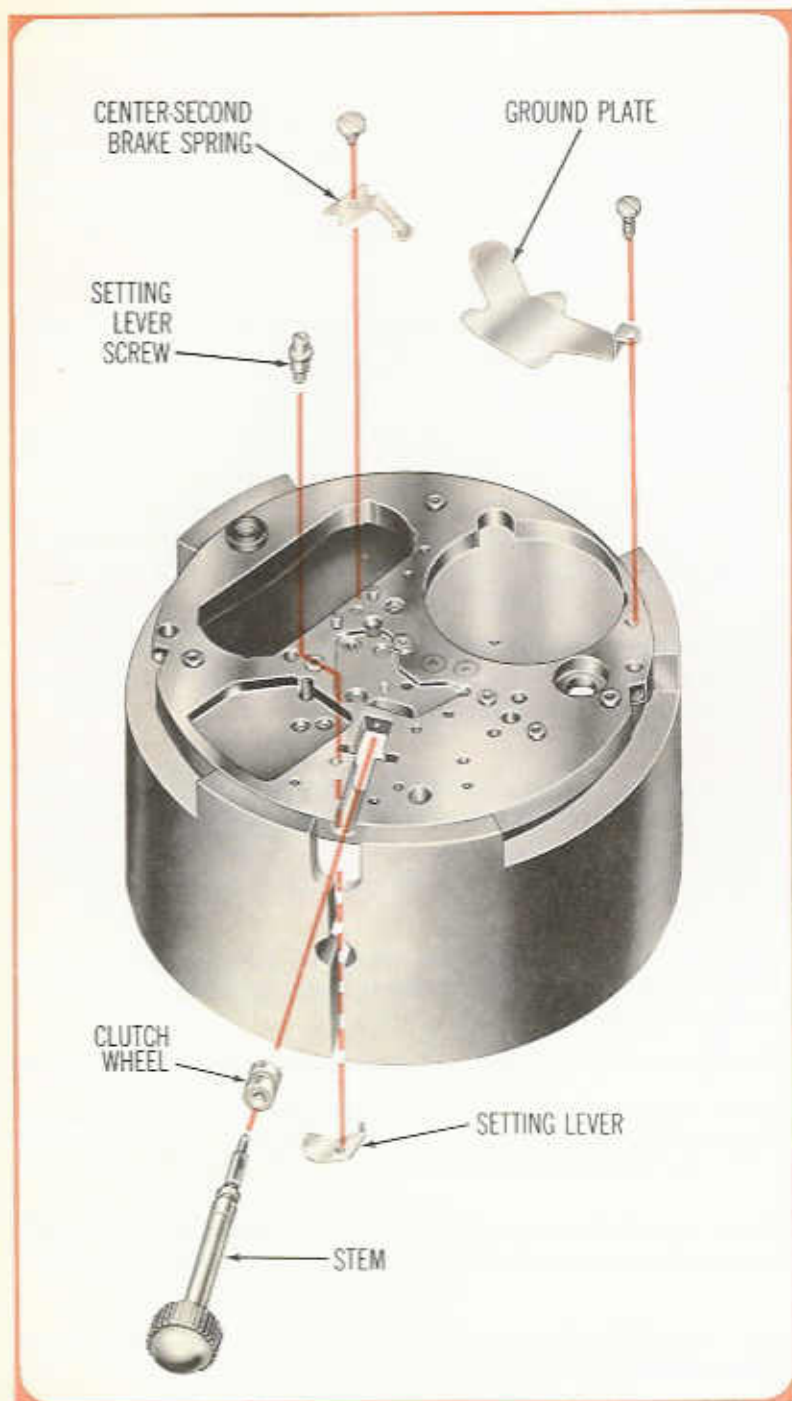

9

Removing setting lever, stem, clutch wheel, center-second brake, and ground plate.

- a. Remove setting lever screw.
- b. Remove setting lever, stem, and clutch wheel.
- c. Remove center-second brake spring (1 screw).
- d. Remove ground plate (1 screw).

Fig. 31

MAY 24 1957

Cleaning

Separate all cap jewels in jewelers devices with spring-held cap jewels from pillar plate and train bridge. After cleaning, replace cap jewel assemblies.

The practice of cleaning a conventional watch, as a routine part of nearly every repair, results from the watchmaker's knowledge that optimum performance and reliability can be expected only when lubrication is fresh. The performance of ACCUTRON is relatively unaffected by the condition of the lubrication. *Cleaning will not usually be required to restore an ACCUTRON timepiece to proper operating condition. When cleaning is necessary, the information on this page is applicable.*

Ultrasonic equipment is necessary for cleaning the ACCUTRON movement. The ACCUTRON movement should be treated exactly as any fine watch movement, with one exception. The electronic circuit, the tuning fork and the pawl bridge **should not be cleaned in ultrasonic equipment**, because of the possibility of damage to delicate parts.

The tuning fork, coils, and pawl bridge can be cleaned satisfactorily by merely dipping into a "benzine cup" and then placing on a tissue to dry.

Care should be taken to prevent metal chips, which may be present in the cleaning cup or on the bench, from being attracted to the permanent magnets on the tines of the tuning fork. Inspect the fork carefully after cleaning, and if this has occurred, any particles that are clinging to the magnets can be removed with masking tape. **NO PARTICLES SHOULD BE LEFT CLINGING TO FORK MAGNETS.**

The center wheel assembly (cannon pinion with center wheel) should not be taken apart, but cleaned as a unit. After cleaning, the wheel should not be rotated until properly lubricated. (See reassembly instruction Page 33.)

The index wheel requires special handling care in cleaning to prevent damage to the index teeth. For this purpose, it is necessary to use a suitable tool to grasp the index wheel pivots when immersing the index wheel in the ultrasonic cleaner. **NEVER HANDLE THE INDEX WHEEL BY THE RIM. GRASP THE PINION ONLY.**

A suitable holding tool for cleaning the index wheel can easily be fabricated by modifying an ordinary pair of watchmaker's tweezers made of brass or other non-magnetic material, as follows:

1. Spot drill the insides of the tweezer tips as shown in the upper section of Fig. 32.
2. Bend a piece of stiff wire around the tweezers and form the wire so that it can be used as a clamp. One end of the wire should be placed between the tweezer tongs.
3. Check that wire clamp locks tweezer tips progressively closer together as clamp is pushed towards the tips.

Note: Authorized Material Distributors can supply, at nominal cost, a special Index Wheel Holder illustrated in lower section of Fig. 32.

MAY 24 1969

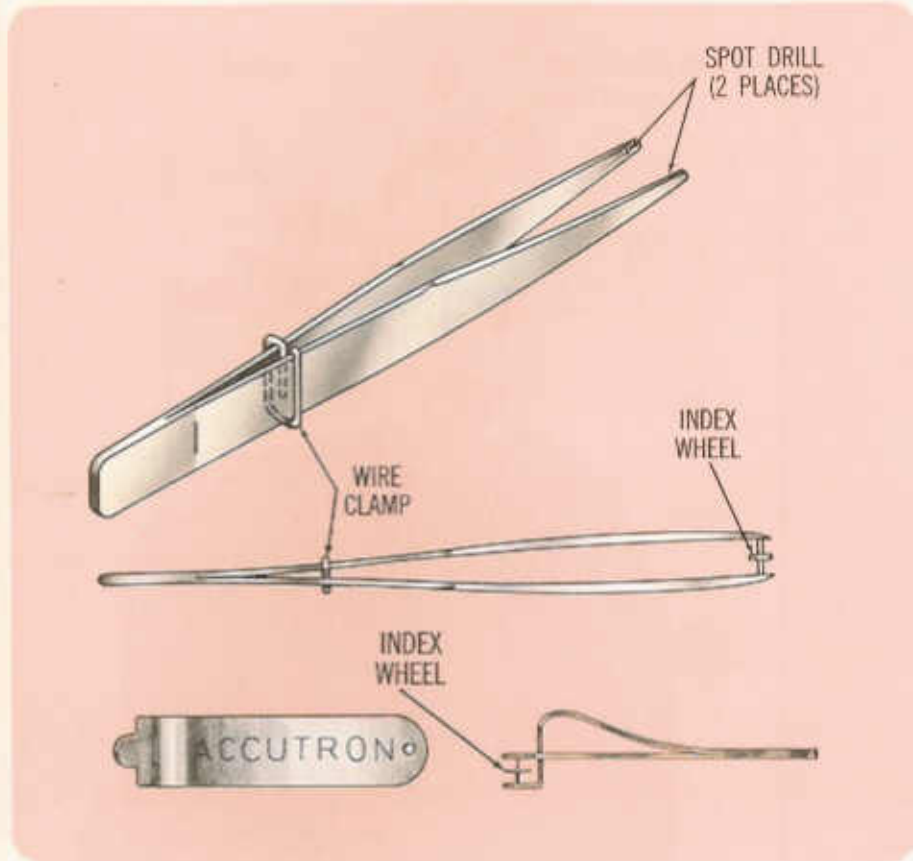

Fig. 32

Lubrication

In the following reassembly procedures, important lubrication instructions are required for the ACCUTRON Series 218. These are as follows:

- Ⓥ Moebius OL219—Synta Visco Lube
- Ⓜ Moebius OL207—Special Lubricant with Molybdenum Disulfide

Both lubricants are available at your Authorized Bulova Materials Distributor.

Reassembly

MAY 24 1957



Replacing setting lever, stem, clutch wheel, center-second brake, and ground plate.

- a. Replace clutch wheel, stem, setting lever, and setting lever screw.
- b. Lubricate stem square and pilot (M)
Use lubricant sparingly.
- c. Replace center-second brake spring (1 screw).
- d. Replace ground plate (1 screw).

(M) Moebius OL 207—Special Lubricant with Molybdenum Disulfide

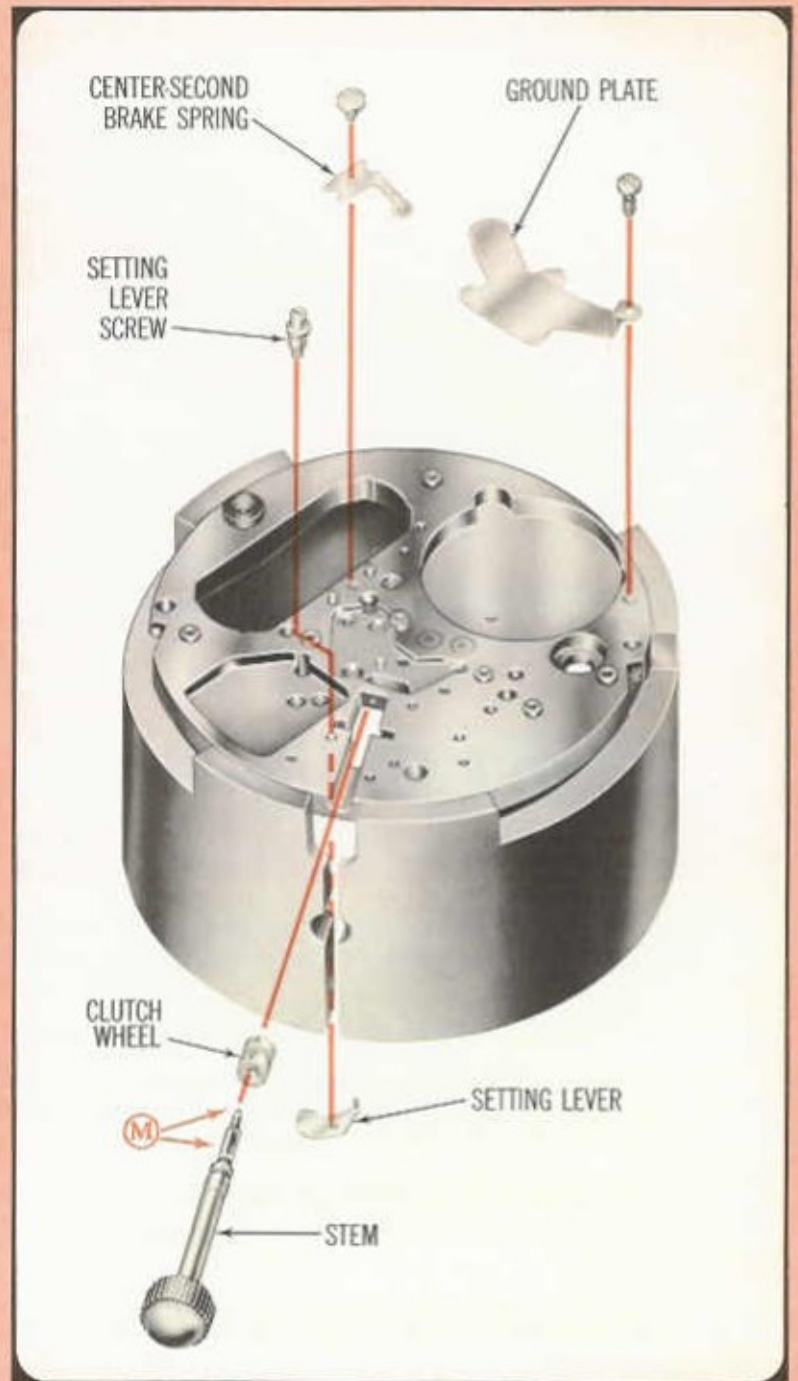
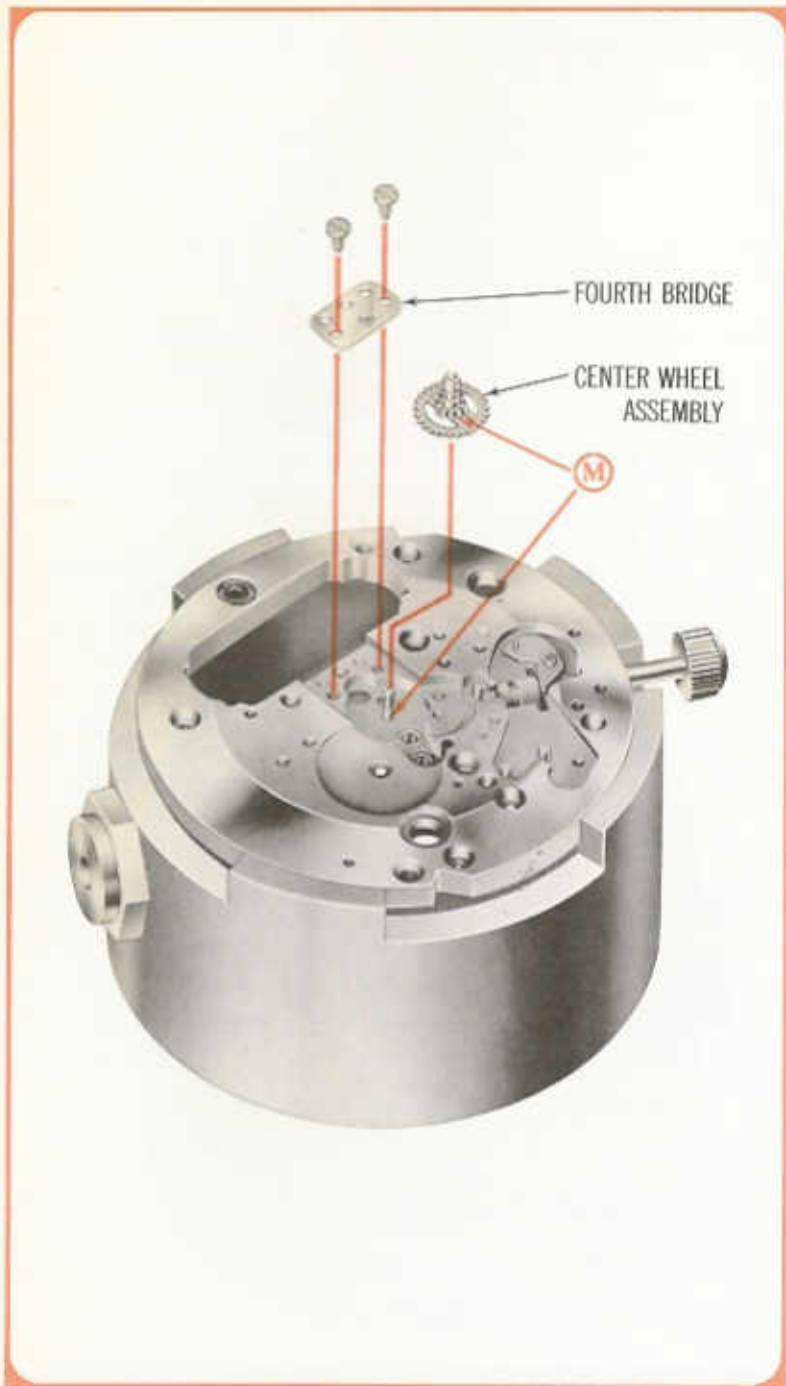

Fig. 33



Replacing center wheel assembly and fourth bridge.

a. Lubricate center wheel assembly and center tube (M). Use lubricant sparingly.

b. Replace center wheel assembly.

c. Replace fourth bridge (2 screws).

(M) Moebius OL 207—Special Lubricant with Molybdenum Disulfide

Fig. 34

MAY 24 1964

3

Replacing minute and setting wheels, clutch lever, and yoke.

- a. Lubricate minute wheel pivot and setting wheel post (M) Use lubricant sparingly.
- b. Replace minute wheel and setting wheel.
- c. Replace clutch lever and clutch lever spring.
- d. Replace yoke (1 screw).
- e. Lubricate yoke (M)

(M) Moebius OL 207—Special Lubricant with Molybdenum Disulfide

CAUTION: If clutch lever is replaced upside down, damage to indexing mechanism can result.

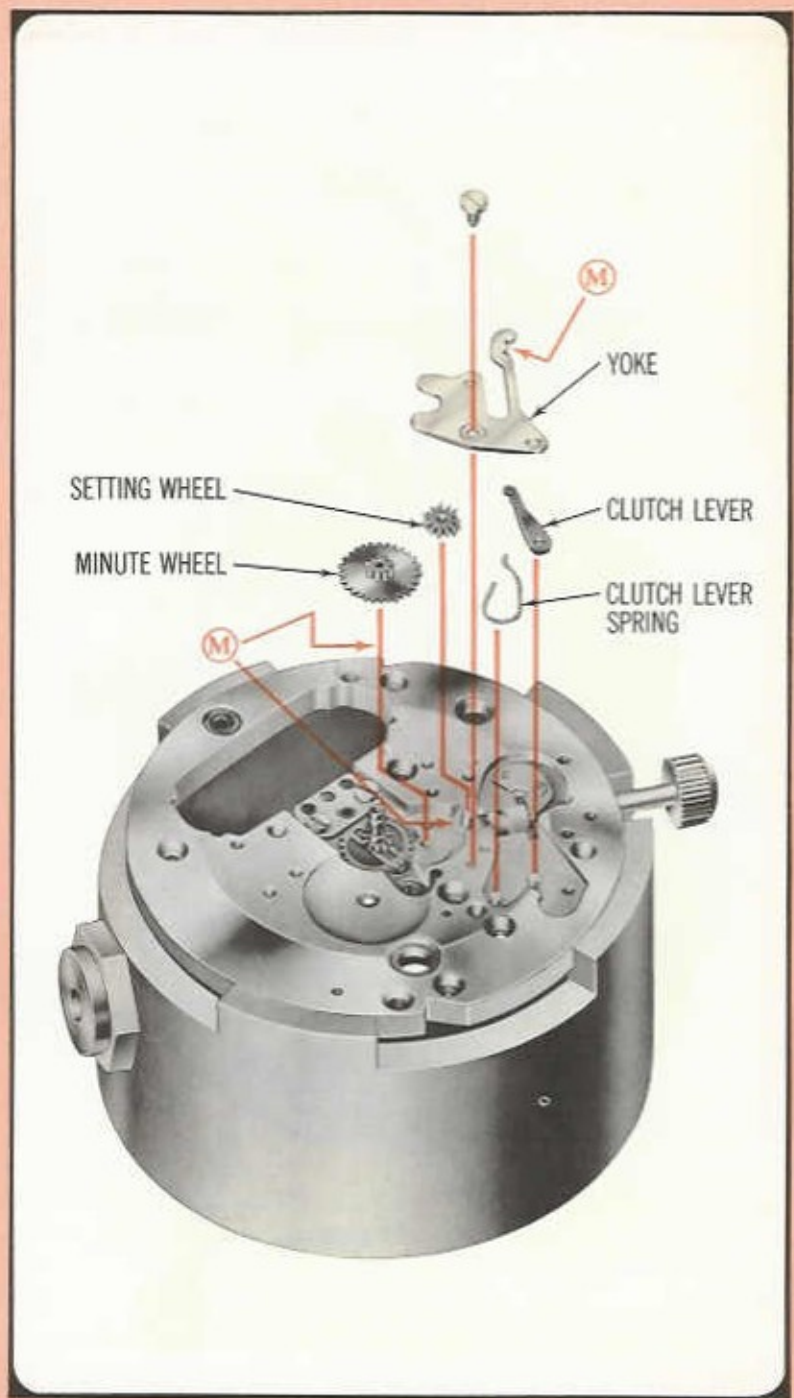
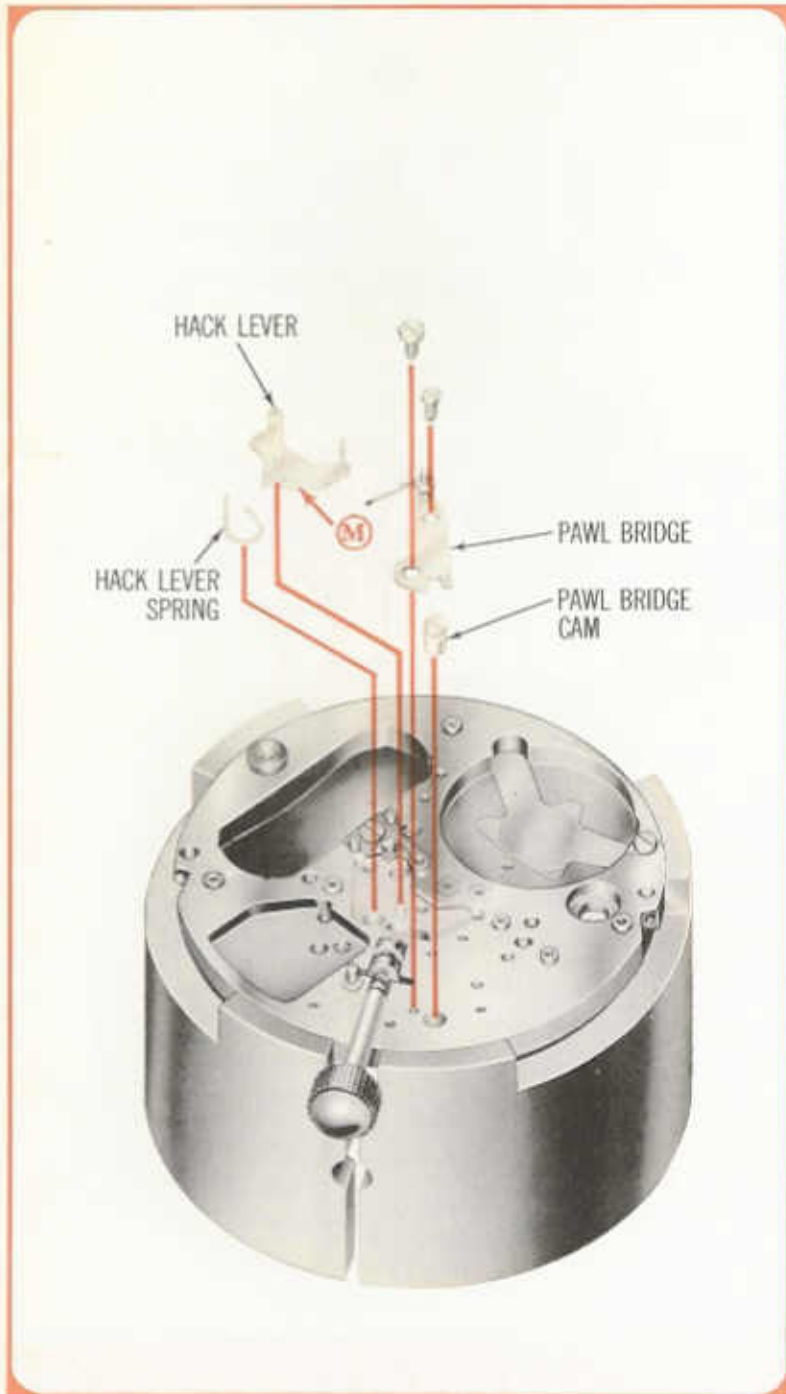

Fig. 35



Replacing hack lever and pawl bridge.

- a. Replace hack lever.
- b. Replace hack lever spring with short leg toward lever, as shown.
- c. Lubricate Stem pilot **M** where it touches hack lever. Use lubricant sparingly.
- d. Replace pawl bridge and cam (2 screws).

M Moebius OL 207—Special Lubricant with Molybdenum Disulfide

Fig. 36

Replacing tuning fork and coil assemblies.

- a. Replace tuning fork and coil assemblies (6 screws).

NOTE: Tuning fork spacers are used to center fork tines between pillar plate and train bridge.

- b. Replace cell strap.

NOTE: Check that cell strap is properly centered on the insulating post of coil form before tightening screw.

- c. Rotate the pawl finger assembly counterclockwise to bring the pawl finger adjacent to the lift pin. Index and pawl jewels should not engage the index wheel at this time.

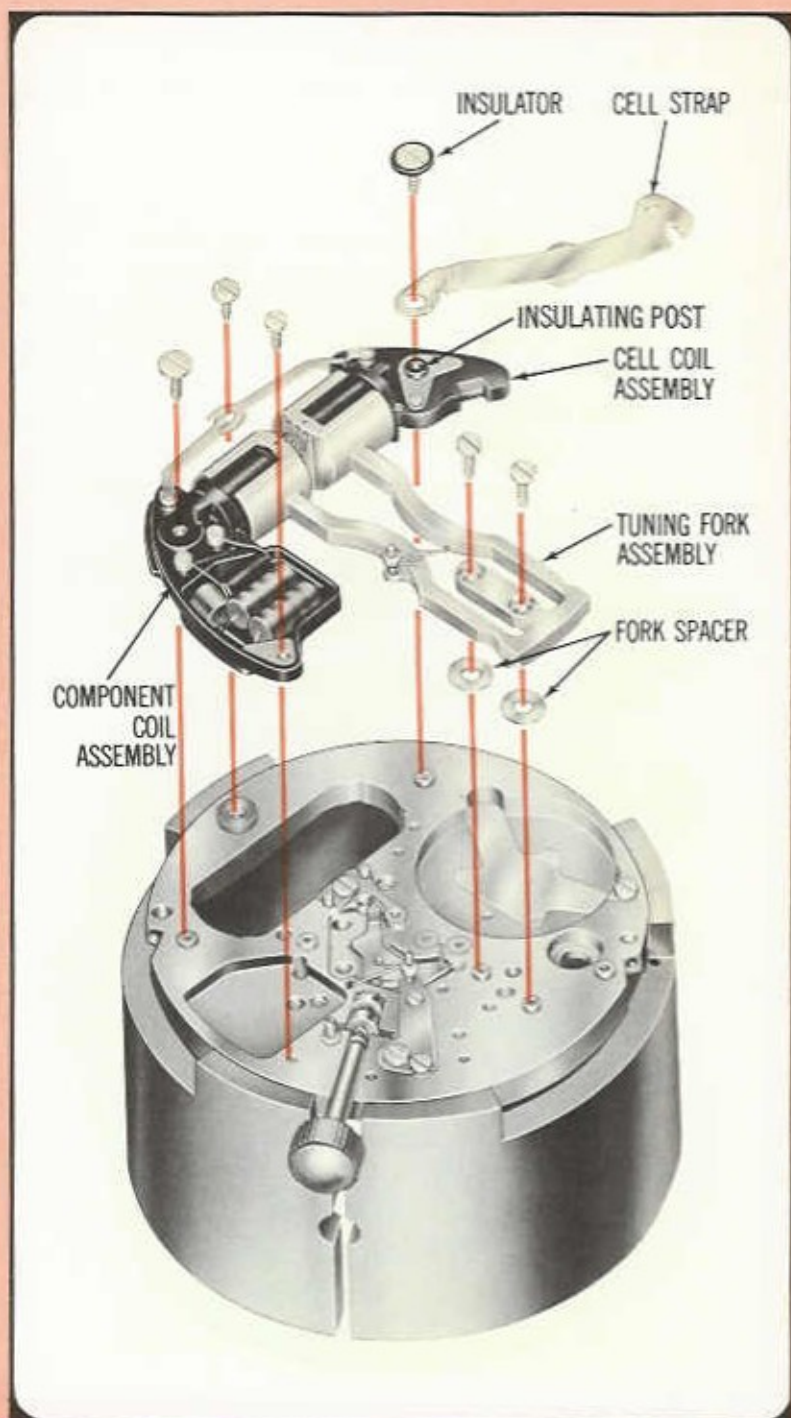
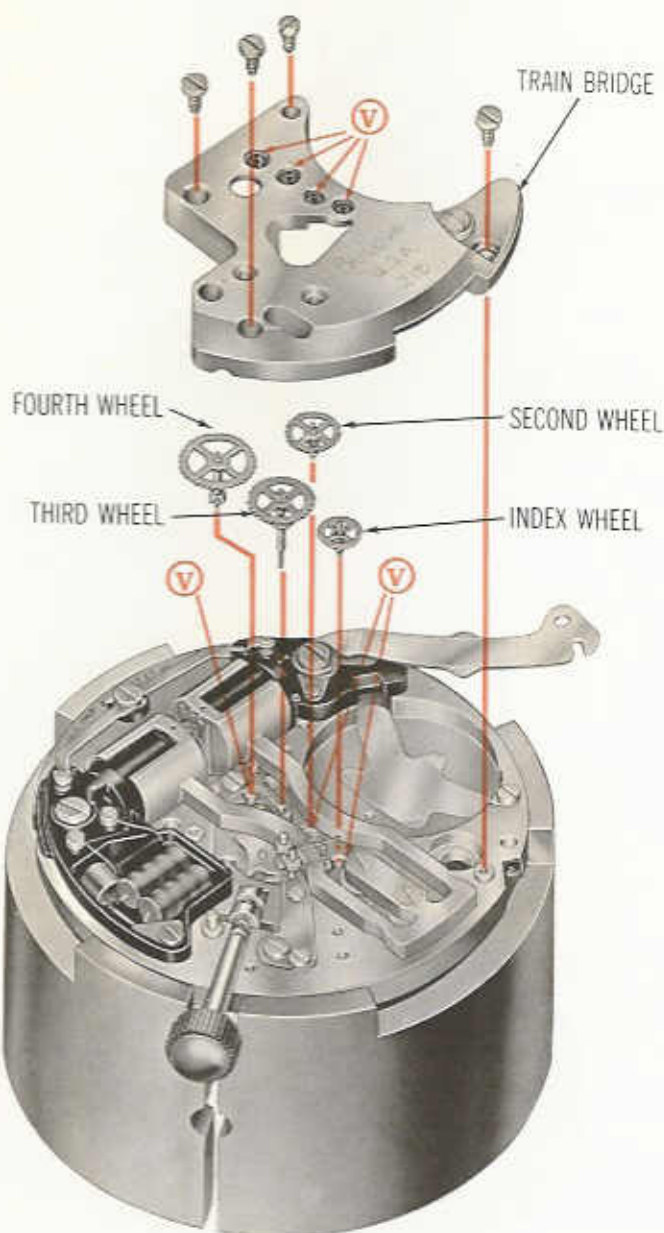

Fig. 37

Replacing train wheels and train bridge.



a. Oil all cap jewels in pillar plate and train bridge (V) Oil sparingly. Do not flood jewels.

b. Push stem in (running position).

c. Replace train wheels.

CAUTION: MAKE CERTAIN THAT PAWL FINGER HAS BEEN ROTATED AS PER STEP 5c, PAGE 36 TO AVOID DAMAGE TO PAWL FINGER. IN ADDITION, MAKE CERTAIN THAT BOTH THE INDEX AND PAWL FINGERS ARE DISENGAGED FROM THE INDEX WHEEL BEFORE PERFORMING THE NEXT STEP.

d. Replace train bridge (4 screws).

e. Oil fourth lower jewel (V) (from dial side).

f. Check wheel train for freedom with tweezers or needle.

(V) Moebius OL 219—Synta Visco Lube

Fig. 38

7

Replacing hour wheel, dial, and hands.

- a. Replace hour wheel and dial washer.
- b. Replace dial (2 screws).
- c. Pull stem out (setting position).
- d. Replace hands.

NOTE: It is necessary to support the center second upper cap jewel on a proper fitting stump in a staking set when replacing center-second hand.

- e. Perform hack mechanism adjustment, page 20.
- f. Perform index mechanism adjustment, pages 15-18.

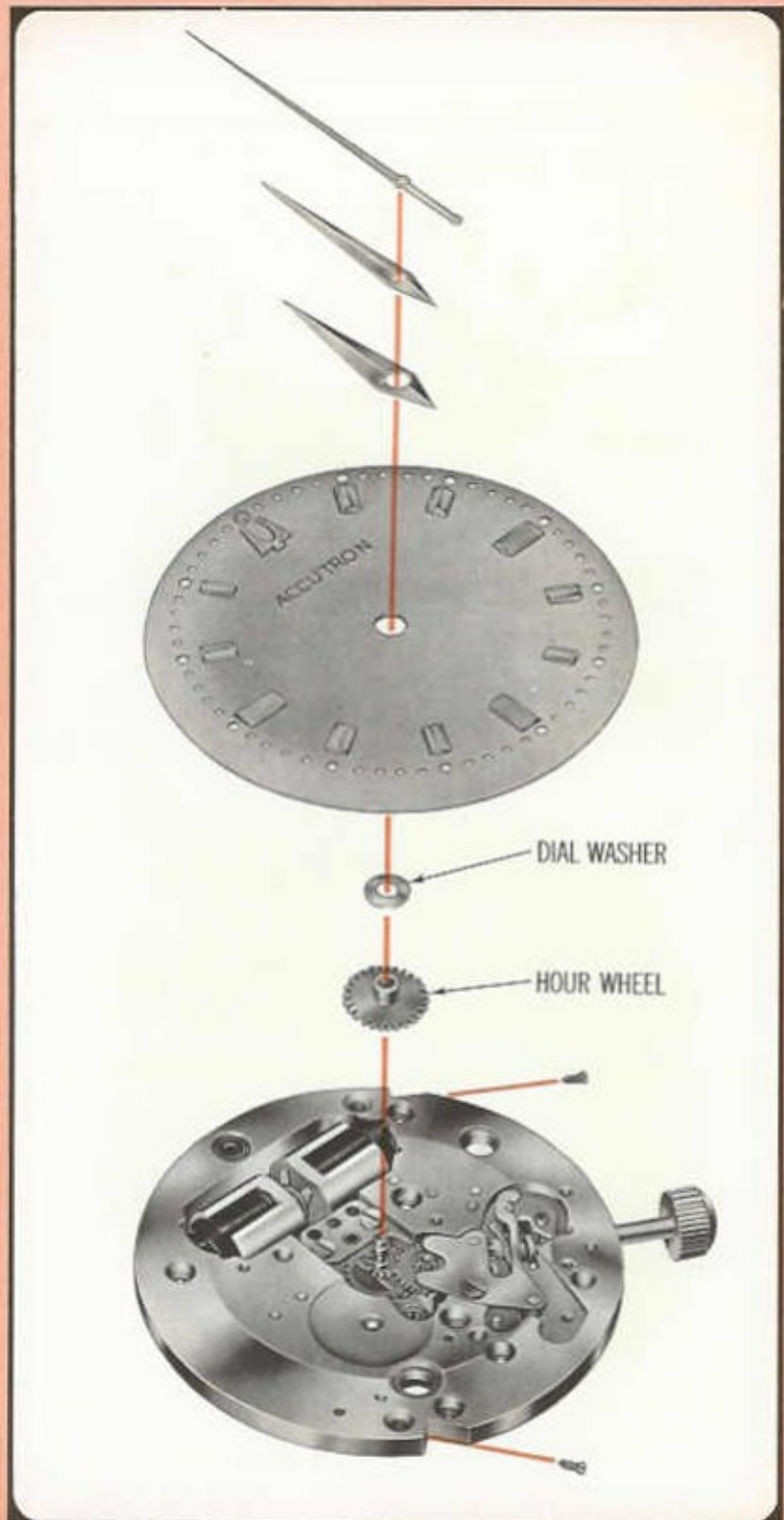

Fig. 39

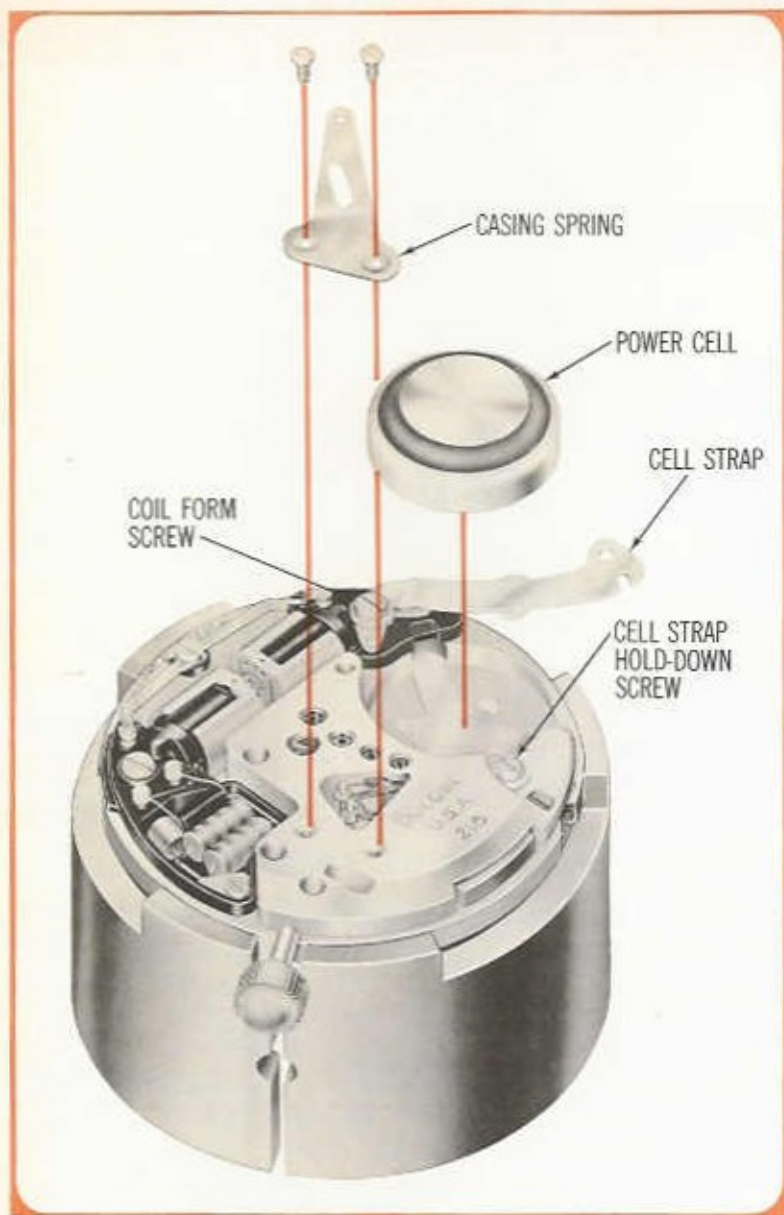

Fig. 40



Replacing casing spring and power cell.

- a. Replace casing spring (2 screws).
- b. Replace power cell (imprinted side down, yellow seal up).
- c. Tighten cell strap and coil form screws.

Replacing movement in case.



See page 8, steps 1 and 2.

Regulation following repair.





After the movement has been replaced in the case, always check regulation (adjust if necessary) to assure that the rate of the *cased* timepiece is approximately two seconds per day slow, in dial up position. The most convenient method is to use the Rate Recorder (see page 11). Otherwise, be certain that an *accurate* time source is used for checking true 24-hour rate.

Basic Parts List series 218

 103 Second Wheel and Pinion	 122 Bridge, Coil, and Fork Foot	 159C Hole Jewel and Setting	 180A Pawl Bridge Sub-Assembly
 105 Third Wheel Assembly	 125 Train Bridge Screw, Pawl Bridge Lock Screw	 159D Spring	 182 Pawl Bridge Cam
 106 Center Tube Assembly	 140 Center Second Hand (To Suit Dial)	 162 Power Cell	 183 Tuning Fork Screw
 107 Fourth Wheel and Pinion	 141 Cell Strap		 184 Pawl Bridge Pivot Screw
 109 Center Wheel Assembly	 142 Minute Hand (To Suit Dial)	 167 Lower Jewel for Fourth Wheel	 186 Fork Spacer
 110 Hour Wheel	 143 Hour Hand (To Suit Dial)	 168 Upper Bushing for Third and Fourth Wheels	 202 Clutch Lever Spring
 111 Minute Wheel and Pinion	 148 Dial Screw	 168B Cap Jewel	 203 Yoke
 112 Index Wheel and Pinion	 151 Coil Form Screw	 168C Hole Jewel and Setting	 204 Clutch Lever
 119 Setting Wheel	 159 Upper and Lower Bushing for Index and Second Wheels	 168D Spring	 205 Setting Lever
 121 Center Second Brake Spring	 159B Cap Jewel	 176A Setting Stem	 207 Clutch Wheel

Replacement spare parts can be ordered from your Bulova Material Distributor.

MAY 24 1969

 Setting Lever Screw 209	 315 Ground Screw	 700 Fourth Bridge
 Hack Lever Spring 211	 319A Casing Spring	 709 Pillar Plate
 Ground Plate 212	 320 Casing Spring Screw	
 Special Train Bridge Screw, Ground Plate Screw 213	 321 Center Second Brake Spring Screw	
 Hack Lever Assembly 220	 404 Train Bridge	
		 715 Cell Coil Assembly
		 Cell Strap Hold-down Screw, Lead Strap Screw 304
 Fourth Bridge Screw 305	 606B Coil Lead Stand-Off Bushing	 716 Tuning Fork Assembly
 Yoke Screw 309	 610 Insulator	 814A Cell Strap Stand-Off Tube

IMPORTANT: Be sure to indicate model number engraved on movement when ordering replacement parts.

MAY 24 1969

Part III

Repair of Date Mechanism in Model 218D

All information and instructions contained in Parts I and II of this manual are also applicable to the Model 218D ACCUTRON (Date Model), with the following exceptions.

Details for disassembling, lubricating, and re-assembling the date mechanism are given in the accompanying illustrations. For all other details concerning service and repair instructions for the basic Series 218 ACCUTRON movement, refer to Part II.

The parts list contained in this Section lists the replacement parts which are used in the Date Model only. The list does not repeat replacement parts that are included in the Basic Parts List in Part II.

When ordering replacement parts, be sure to indicate that the parts are for Model 218D. For example, if you are ordering a new clutch wheel, Part No. 208, write the Part Number as follows: 218D208.

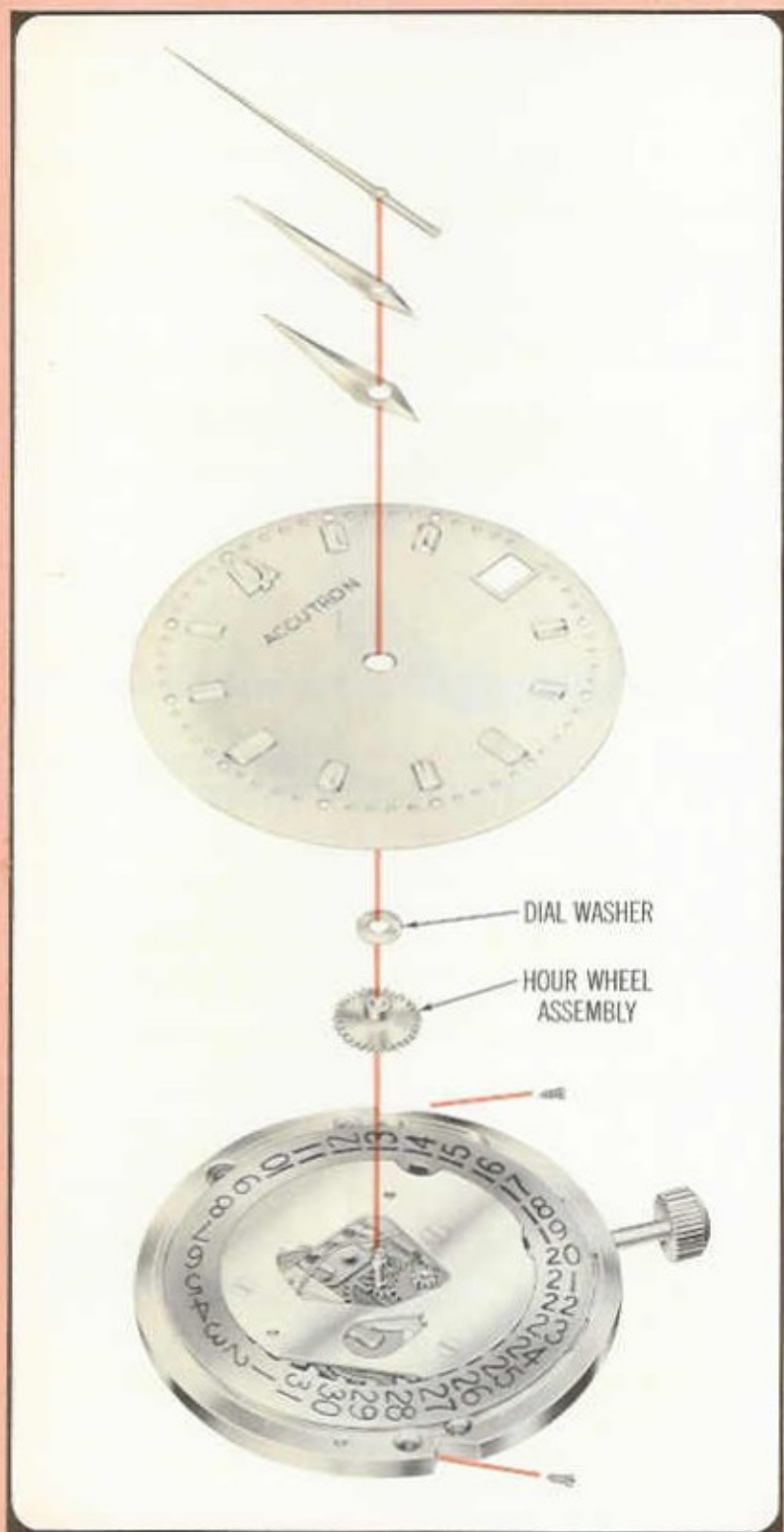

Removing hands, dial, and hour wheel

- a. Pull stem out (setting position).
- b. Remove hands.
- c. Remove dial (2 screws).
- d. Remove hour wheel with dial washer.

Fig. 41

MAY 24 1969

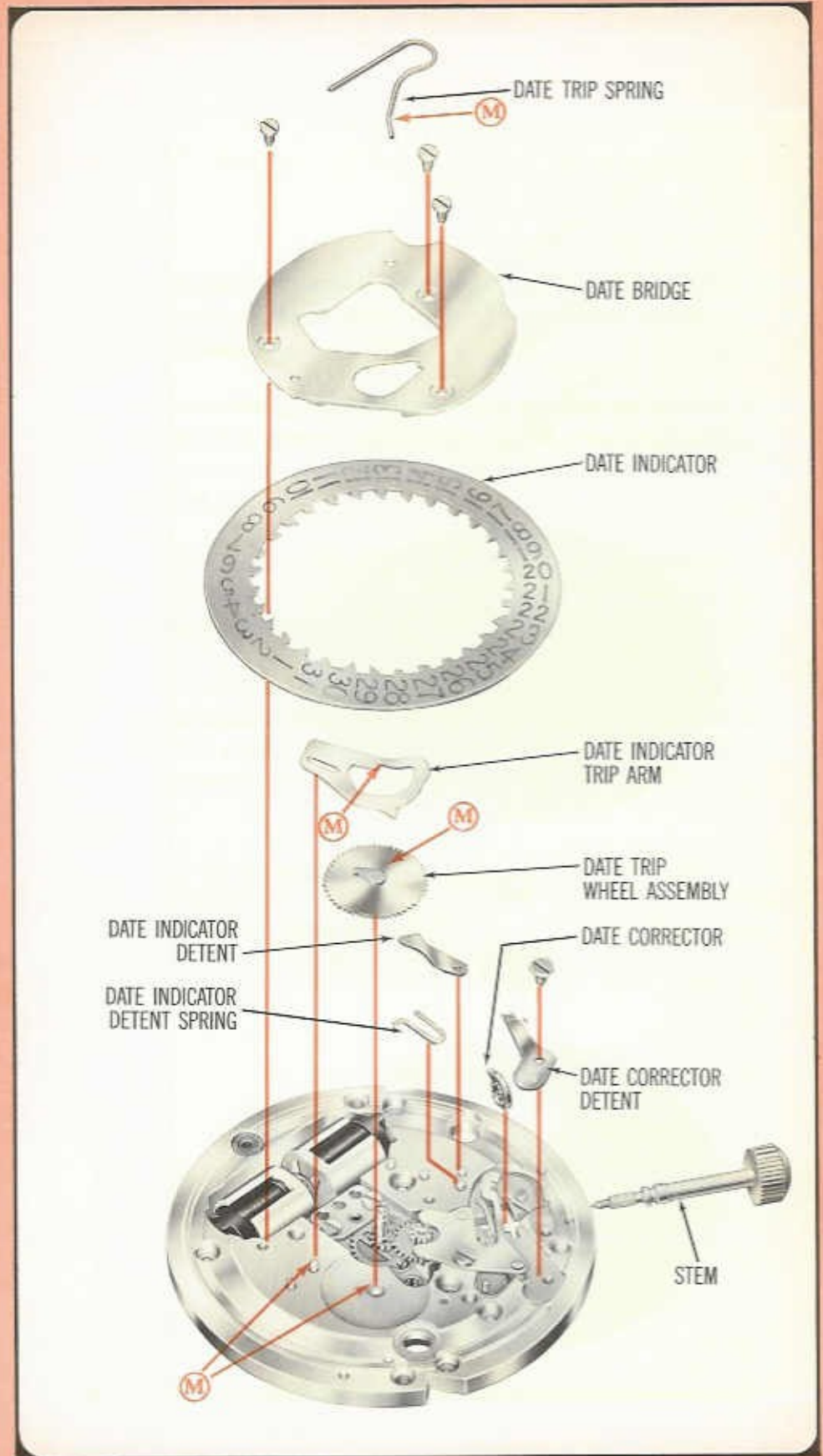

Fig. 42

Date Mechanism Disassembly

- a. Remove date trip spring by collapsing open end sufficiently to slide into recess above trip arm until loop end is clear of its recess. Spring may then be withdrawn from date bridge.
- b. Remove date bridge (3 screws).

Caution: Lift with care to avoid loss of date indicator detent spring.
- c. Remove date indicator detent spring, date indicator detent and date indicator.
- d. Remove date trip arm and date trip wheel assembly.
- e. Remove stem (See Procedure 1, page 8), and date corrector.
- f. Remove date corrector detent (1 screw).



Date Mechanism Lubrication and Reassembly

- a. Replace date corrector detent (1 screw).
- b. Lubricate and replace date corrector with stem and clutch wheel. (See Reassembly and Lubrication, Procedure 1, page 32.)
- c. Lubricate date trip wheel pivot (M) and replace date trip wheel assembly and date indicator trip arm. Use lubricant sparingly.
- d. Oil date trip arm pin (M). Use lubricant sparingly.
- e. Replace date indicator, date indicator detent and date indicator detent spring.
- f. Replace date bridge (3 screws).

Note: Make certain date trip arm is not trapped between pillar plate and date bridge before tightening screws.
- g. Apply a small amount of lubricant (M) to lower end of date trip spring which engages date trip arm. Use lubricant sparingly.
- h. Replace date trip spring by collapsing open end sufficiently to permit insertion into date bridge recess above date trip arm, then slide loop end into its recess, making certain that upper end of spring snaps into cutout.
- i. Lubricate date indicator trip arm (M). Use lubricant sparingly.



(M) Moebius OL 207 - Special Lubricant with Molybdenum Disulfide

MAY 24 1963

4

Replacing hour wheel, dial, and hands.

- a. Replace hour wheel and dial washer.
- b. Replace dial (2 screws).
- c. Pull stem out (setting position), advance dial train slowly forward until date indicator jumps to the next date.
- d. Replace hands exactly at 12 o'clock.

NOTE: It is necessary to support the center second upper cap jewel on a proper fitting stump in a staking set when replacing center-second hand.

- e. Perform hack mechanism adjustment, page 20.
- f. Perform index mechanism adjustment, pages 15-18.

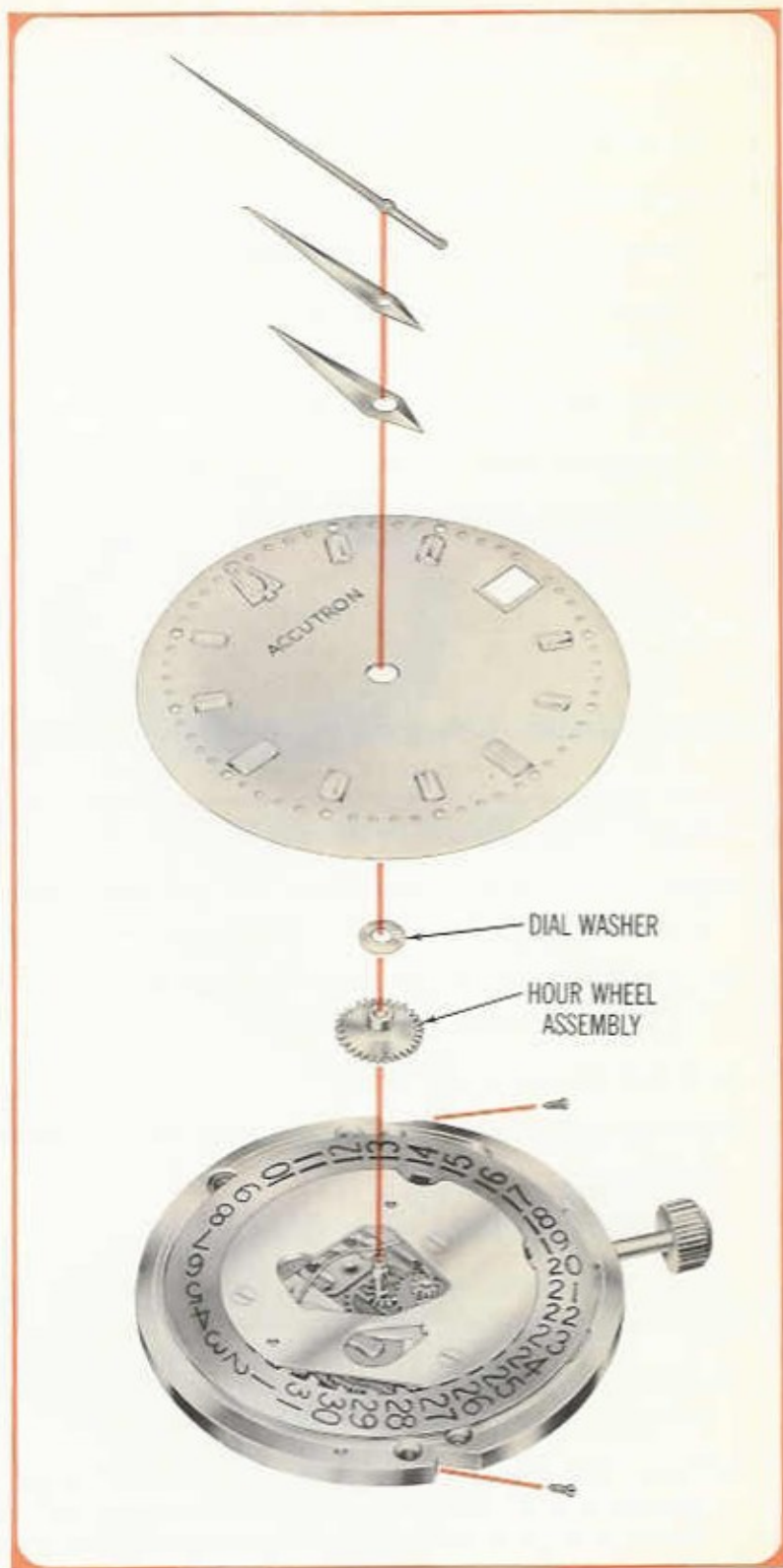



Fig. 43

MAY 24 1969

Parts List model 218D

(All other parts same as basic series 218)

 <p>208 Clutch Wheel</p>	 <p>576 Date Indicator (Specify Dial Aperture and Crown Location)</p>
 <p>305 Date Bridge Screw</p>	 <p>579 Center Wheel Assembly</p>
 <p>321 Date Corrector Detent Screw</p>	 <p>580 Minute Wheel Assembly</p>
 <p>569 Date Corrector</p>	 <p>581 Date Trip Arm</p>
 <p>570 Date Corrector Detent</p>	 <p>582 Date Trip Spring</p>
 <p>571 Date Bridge</p>	 <p>599 Hour Wheel Assembly</p>
 <p>572 Date Indicator Detent</p>	 <p>709 Pillar Plate</p>
 <p>573 Date Indicator Detent Spring</p>	
 <p>574 Date Trip Wheel Assembly</p>	

IMPORTANT: Be sure to indicate model number engraved on movement when ordering replacement parts.

MAY 24 1969

Index

A

Adjustment, indexing mechanism 15

C

Casing spring
 Removing 22
 Replacing 39
Case, closing 8
 opening 3
Center-second brake
 Removing 29
 Replacing 32
Center wheel assembly
 Removing 28
 Replacing 33
Circuit, testing 19
Cleaning 30
Cleaning equipment 11
Clutch lever
 Removing 27
 Replacing 34
Clutch wheel
 Removing 29
 Replacing 32
Coil and tuning fork assemblies
 Removing 25
 Replacing 36
Coil assembly, identifying defective 20
Collet adjusting tool 11

D

Date mechanism
 Disassembly 45
 Lubrication 45
 Reassembly 45
Date mechanism, repair of 42-46
Diagnostic chart 12-13

Dial

Removing, Basic 218 21
Removing, model 218D 43
Replacing, Basic 218 38
Replacing, model 218D 46

Disassembly 21-29

Disassembly, Date mechanism 45

E

Electronic circuit, testing 19

F

Fourth bridge
 Removing 28
 Replacing 33

G

Ground plate
 Removing 29
 Replacing 32

H

Hack lever
 Removing 26
 Replacing 35
Hack mechanism
 Inspection and adjustment 20

Hands 14

Removing, Basic 218 21
Removing, model 218D 43
Replacing, Basic 218 38
Replacing, model 218D 46

Hour wheel

Removing, Basic 218 21
Removing, model 218D 43
Replacing, Basic 218 38
Replacing, model 218D 46

I

Index and pawl finger
 Disengaging 23
Index jewel 16, 17

Index continued

Index wheel 14, 30, 31
Indexing mechanism 14, 15-18

L

Locking-ring wrench 11
Lubrication 14, 31
 Date mechanism 45

M

Magnetism 14
Microscope 2, 14
Minute wheel
 Removing 27
 Replacing 34

Model 218D 42-46

Movement

 Removing from case 7
 Replacing in case 8

Movement holder 10

P**Parts list**

 Basic 218 40, 41
 Model 218D 47

Pawl bridge

 Removing 26
 Replacing 35

Pawl jewel 16, 18

Power cell

 Removing 22
 Replacing 4, 39
 Testing 19

R

Rate recorder 11
Reassembly 32-39
Reassembly, Date mechanism 45
Regulation 5, 6
Regulation following repair 39
Regulators 5

S

Service kit 9-11
Servicing chart 12-13
Setting lever
 Removing 29
 Replacing 32
Setting wheel
 Removing 27
 Replacing 34
Special points 14
Special tools and
 equipment 9-11
Stem 14
 Removing 29
 Replacing 32
Stress limiters 17

T

Test set 9, 10
Tool, for cleaning index wheel 31
Train bridge and train wheels
 Removing 24
 Replacing 37
Train, checking for freedom 20
Trouble symptoms 12-13
Tuning fork and coil assemblies
 Removing 25
 Replacing 36

U

Ultrasonic cleaning 11, 30

W

WATCHMASTER products 11

Y

Yoke
 Removing 27
 Replacing 34

